

# EVS-2000 USER

10th Gen. Intel® Xeon® / Core™ i9/i7/i5/i3 Fanless AI Computing System with  
NVIDIA® / AMD MXM GPU Graphics, High Performance Expandable

# Manual

## Record of Revision

---

Version	Date	Page	Description	Remark
1.00	01/28/2021	All	Official Release	
1.10	01/29/2021	29, 42	Update	
1.20	02/25/2021	8, 10	Update	
1.30	03/11/2021	4, 6, 8, 10, 20	Update	
1.40	08/04/2021	3, 5, 7, 9, 25	Update	
1.50	11/12/2021	50	Update	
1.60	08/26/2022	124-126	Update	
1.70	11/03/2022	32	Update	
1.80	06/06/2023	13-14, 69, 111	Update	

## Disclaimer

This manual is released by Vecow Co., Ltd. for reference purpose only. All product offerings and specifications are subject to change without prior notice. Vecow Co., Ltd. is under no legal commitment to the details of this document. Vecow shall not be liable for direct, indirect, special, incidental, or consequential damages arising out of the use of this document, the products, or any third party infringements, which may result from such use.

## Declaration of Conformity

**FCC** This equipment has been tested and found to comply with the limits for a Class A digital device, pursuant to part 15 of the FCC Rules. These limits are designed to provide reasonable protection against harmful interference when the equipment is operated in a commercial environment. This equipment generates, uses, and can radiate radio frequency energy, and if it is not installed and used in accordance with the instruction manual, it may cause harmful interference to radio communications. Operation of this equipment in a residential area is likely to cause harmful interference in which case the user will be required to correct the interference at his own expense.

**CE** The products described in this manual comply with all applicable European Union (CE) directives if it has a CE marking. For computer systems to remain CE compliant, only CE-compliant parts may be used. Maintaining CE compliance also requires proper cable and cabling techniques.

## Copyright and Trademarks

This document contains proprietary information protected by copyright. No part of this publication may be reproduced in any form or by any means, electric, photocopying, recording or otherwise, without prior written authorization by Vecow Co., Ltd. The rights of all the brand names, product names, and trademarks belong to their respective owners.

## Order Information

Part Number	Description
EVS-2010	EVS-2000, 2 GigE LAN, 1 PCIe x4, 6 USB 3.2, 3 COM, 2 SIM, 32 Isolated DIO, Fanless
EVS-2001	EVS-2000, 2 GigE LAN, 1 PCI, 6 USB 3.2, 3 COM, 2 SIM, 32 Isolated DIO, Fanless
EVS-2010F	EVS-2000, 2 GigE LAN, 1 PCIe x4, 6 USB 3.2, 3 COM, 2 SIM, 32 Isolated DIO, With System Fan
EVS-2001F	EVS-2000, 2 GigE LAN, 1 PCI, 6 USB 3.2, 3 COM, 2 SIM, 32 Isolated DIO, With System Fan

## CPU List

Series	CPU	Cores	GHz	TDP (W)	ECC RAM
Intel® Xeon®	W-1290TE	10	4.5	35	Yes
	W-1270TE	8	4.4	35	Yes
	W-1250TE	6	3.8	35	Yes
Intel® Core™	i9-10900E	10	4.7	65	NA
	i9-10900TE	10	4.5	35	NA
	i7-10700E	8	4.5	65	NA
	i7-10700TE	8	4.4	35	NA
	i5-10500E	6	4.2	65	NA
	i5-10500TE	6	3.7	35	NA
	i3-10100E	4	3.8	65	Yes
	i3-10100TE	4	3.6	35	Yes

## Order Accessories

---

Part Number	Description
DDR4 32G	Certified DDR4 32GB 3200MHz RAM
DDR4 16G	Certified DDR4 16GB 3200MHz RAM
DDR4 8G	Certified DDR4 8GB 3200MHz RAM
DDR4 4G	Certified DDR4 4GB 3200MHz RAM
PWA-160WB-WT	160W, 24V, 85V AC to 264V AC Power Adaptor with 3-pin Terminal Block (7.62mm pitch), Wide Temperature -30°C to +70°C
PWA-280WB-WT	280W, 24V, 85V AC to 264V AC Power Adaptor with 3-pin Terminal Block (7.62mm pitch), Wide Temperature -30°C to +70°C
PWS-480W-WT	480W, 24V, 90V AC to 305V AC Power Supply, Wide-Temp, IP65
VESA Mount	VESA Mounting Kit
DIN-RAIL	DIN Rail Kit and VESA Mounting Kit
Rack Mount	2U Rackmount Kit
TMK2-20P-100	Terminal Block 20-pin to Terminal Block 20-pin Cable, 100cm
TMK2-20P-500	Terminal Block 20-pin to Terminal Block 20-pin Cable, 500cm
TMB-TMBK-20P	Terminal Board with One 20-pin Terminal Block Connector and DIN-Rail Mounting
M.2 Storage Module	M.2 Key M/Key B PCIe Storage Module
5G Module	5G Module with Antenna
4G Module	4G/GPS Module with Antenna
WiFi & Bluetooth	WiFi & Bluetooth Module with Antenna

# Table of Contents

<b>CHAPTER 1</b>	<b>GENERAL INTRODUCTION</b>	<b>1</b>
1.1	Overview	1
1.2	Features	2
1.3	Product Specification	3
1.3.1	Specifications of EVS-2010	3
1.3.2	Specifications of EVS-2001	5
1.3.3	Specifications of EVS-2010F	7
1.3.4	Specifications of EVS-2001F	9
1.4	Supported CPU List	11
1.5	Mechanical Dimension	12
1.5.1	Dimensions of EVS-2000	12
1.5.2	Dimensions of EVS-2000F	12
<b>CHAPTER 2</b>	<b>GETTING TO KNOW YOUR EVS-2000</b>	<b>13</b>
2.1	Packing List	13
2.1.1	Packing List of EVS-2000	13
2.1.2	Packing List of EVS-2000F	14
2.2	Front Panel I/O & Functions	15
2.3	Rear Panel I/O & Functions	22
2.4	Main Board Expansion Connectors	29
2.5	Main Board Jumper Settings	43
2.6	Ignition Control	48
<b>CHAPTER 3</b>	<b>SYSTEM SETUP</b>	<b>51</b>
3.1	How to Open Your EVS-2000	51
3.2	Installing CPU	54
3.3	Installing DDR4 SO-DIMM Modules	60
3.4	Installing Mini PCIe Card	61
3.5	Installing M.2 (Key B/E/M)	62
3.6	Installing Antenna Cable	65
3.7	Installing SIM Card	67

3.8	Installing SD Card	68
3.9	Installing PCI/PCIe Card	69
3.10	Installing SSD/HDD	71
3.11	Mounting Your EVS-2000	73
<b>CHAPTER 4</b>	<b>BIOS AND DRIVER</b>	<b>76</b>
4.1	BIOS Settings	76
4.2	Main	77
4.3	Advanced	77
4.4	Chipset	90
4.5	Security	96
4.6	Boot	98
4.7	Save & Exit	99
<b>APPENDIX A</b>	<b>: Isolated DIO Guide</b>	<b>100</b>
<b>APPENDIX B</b>	<b>: Software Functions</b>	<b>104</b>
<b>APPENDIX C</b>	<b>: RAID Functions</b>	<b>109</b>
<b>APPENDIX D</b>	<b>: Power Consumption</b>	<b>114</b>
<b>APPENDIX E</b>	<b>: Supported Memory &amp; Storage List</b>	<b>122</b>
<b>APPENDIX F</b>	<b>: Install Win11 (BIOS TPM Setting)</b>	<b>124</b>

# 1

## GENERAL INTRODUCTION

### 1.1 Overview

Vecow EVS-2000 Series is a high-performance Fanless Embedded GPU Computing System. Designed with MXM Graphics modules, Vecow EVS-2000 Series is based on 10th Gen Intel® Xeon®/Core™ processor and features advanced Intel® UHD Graphics 630. Equipped with Intel® W480E chipset, Vecow EVS-2000 Series supports DDR4-2933 with up to 64GB of memory. Featuring advanced NVIDIA® with NVIDIA Turing™ architecture technology or AMD Graphics in the support for MXM 3.1 Type A and Type B form factor, Vecow EVS-2000 supports up to 7 independent displays with up to 8K resolution, delivering astounding visual computing performance and accelerating compact-specific applications.

Vecow EVS-2000 Series offers a wide range of I/O connectivity including 2 GigE LAN, 6 USB, 3 COM, 2 SIM, as well as M.2 to allow flexible expansions and integrations such as WWAN/WLAN/PCIe storage and CAN Bus. It is fanless and supports -40°C to 60°C extended operating temperature, 9V to 50V DC-in, as well as software ignition power control and TPM 2.0, Vecow EVS-2000 Series is ideal for industrial applications.

Powered by 10th Gen Intel® Xeon®/Core™ i9/i7/i5/i3 processor, Vecow EVS-2000 Series delivers outstanding computing performance and meets compact AI applications requirements in Facial Recognition, Factory Automation, Smart Retail, Machine Vision, Autonomous Car and AIoT or Industry 4.0 applications.



## 1.2 Features

- LGA 1200 Socket Type 10-core 10th Gen Intel® Xeon®/Core™ i9/i7/i5/i3 Processor (Comet Lake-S) with Intel® W480E chipset
- Dual 260-pin SO-DIMM support up to 64GB DDR4 memory
- Compact NVIDIA® Quadro®/GeForce® MXM graphics card delivers leading AI computing productivity by advanced NVIDIA® CUDA® cores
- Fanless, -25°C to 55°C Operating Temperature
- Nano SIM Sockets for 5G/WiFi/4G/3G/LTE/GPRS/UMTS
- Expansion : 1 M.2 Key B, 1 M.2 Key E, 1 Mini PCIe, optional SUMIT A, B
- Storage : 2 2.5" SSD Tray, 1 Micro SD Card, 1 M.2 Key M, 1 M.2 Key B
- 9V to 50V wide range DC Power Input with 80V Surge Protection
- Supports Configurable Software Ignition Power Control and TPM 2.0
- Optional VHub One-Stop AIoT Solution Service supports OpenVINO based AI accelerator and advanced Edge AI applications

## 1.3 Product Specification

### 1.3.1 Specifications of EVS-2010

System	
Processor	LGA 1200 Socket supports 10th Gen Intel® Xeon®/Core™ i9/i7/i5/i3 Processor (Comet Lake-S)
Chipset	Intel® W480E
BIOS	AMI
SIO	IT8786E
Memory	<ul style="list-style-type: none"> <li>• 2 DDR4 2933MHz</li> <li>• Up to 64GB</li> <li>• 2 260-pin SO-DIMM Socket</li> </ul>
I/O Interface	
Serial	3 COM RS-232/422/485 (ESD 8kV)
USB	6 External USB 3.2 (External)
Isolated DIO	32 Isolated DIO : 16 DI, 16 DO
LED	Power, HDD
SIM Card	2 External Nano SIM Card Socket
SD Card	1 External Micro SD Card Socket
Expansion	
Mini PCIe	1 Mini PCIe Socket for PCIe/USB/SIM Card/mSATA
PCI/PCIe	1 PCIe x4 Slot
M.2	<ul style="list-style-type: none"> <li>• 1 M.2 Key B Socket (3042/3052)</li> <li>• 1 M.2 Key E Socket (2230)</li> </ul>
SUMIT A, B	2 SUMIT Slot (Optional)
Graphics	
Graphics Processor	<ul style="list-style-type: none"> <li>• Intel® UHD Graphics 630</li> <li>• Independent MXM Graphics : By request</li> <li>• MXM Graphics TDP : 50W</li> </ul>
Interface	Up to 7 independent displays : <ul style="list-style-type: none"> <li>• 1 VGA : Up to 1920 x 1200 @ 60Hz</li> <li>• 1 DVI-D : Up to 1920 x 1200 @ 60Hz</li> <li>• 2 DisplayPort : Up to 4096 x 2304 @ 60Hz</li> <li>• 4 DisplayPort : Up to 7680 x 4320 @ 60Hz (By requested MXM)</li> </ul>
Storage	
SATA	2 SATA III (6Gbps) support S/W RAID 0, 1
mSATA	1 SATA III (Mini PCIe Type, 6Gbps)
M.2	<ul style="list-style-type: none"> <li>• 1 M.2 Key B Socket (2280)</li> <li>• 1 M.2 Key M Socket (2280)</li> </ul>
Storage Device	<ul style="list-style-type: none"> <li>• 1 Micro SD Card Socket, Push-in/Push-out Ejector</li> <li>• 2 Front-access 2.5" SSD/HDD Tray</li> </ul>

<b>Audio</b>	
Audio Codec	Realtek ALC888S-VD, 7.1 Channel HD Audio
Audio Interface	1 Mic-in, 1 Line-out
<b>Ethernet</b>	
LAN 1	Intel® I219LM GigE LAN supports iAMT 14.0
LAN 2	Intel® I210 GigE LAN
<b>Power</b>	
Input Voltage	9V to 50V, DC-in
Power Interface	3-pin Terminal Block : V+, V-, Frame Ground
Ignition Control	16-mode Software Ignition Control
Remote Switch	3-pin Terminal Block : On, Off, IGN
Surge Protection	Up to 80V/1ms Transient Power
<b>Others</b>	
TPM	Infineon SLB9665 supports TPM 2.0, LPC interface
Watchdog Timer	Reset : 1 to 255 sec./min. per step
Smart Management	Wake on LAN, PXE supported
HW Monitor	Monitoring temperature, voltages. Auto throttling control when CPU overheats.
<b>Software Support</b>	
OS	Windows 10, Linux
<b>Mechanical</b>	
Dimension (W x D x H)	280.0mm x 215.0mm x 79.1mm (11.02" x 8.46" x 3.11")
Weight	4.9 kg (10.80 lbs)
Mounting	<ul style="list-style-type: none"> <li>• Wallmount by mounting bracket</li> <li>• DIN Rail Mount (Optional)</li> <li>• 2U Rackmount (Optional)</li> </ul>
<b>Environment</b>	
Operating Temperature	<b>35W TDP CPU</b> : -25°C to 55°C (-13°F to 131°F) <b>65W TDP CPU</b> : -25°C to 45°C (-13°F to 113°F)
Storage Temperature	-40°C to 85°C (-40°F to 185°F)
Humidity	5% to 95% humidity, non-condensing
Relative Humidity	95% @55°C
Shock	<ul style="list-style-type: none"> <li>• IEC 60068-2-27</li> <li>• SSD : 50G @ wallmount, Half-sine, 11ms</li> </ul>
Vibration	<ul style="list-style-type: none"> <li>• IEC 60068-2-64</li> <li>• SSD : 5Grms, 5Hz to 500Hz, 3 Axis</li> </ul>
EMC	CE, FCC, EN50155, EN50121-3-2

### 1.3.2 Specifications of EVS-2001

<b>System</b>	
Processor	LGA 1200 Socket supports 10th Gen Intel® Xeon®/Core™ i9/i7/i5/i3 Processor (Comet Lake-S)
Chipset	Intel® W480E
BIOS	AMI
SIO	IT8786E
Memory	<ul style="list-style-type: none"> <li>• 2 DDR4 2933MHz</li> <li>• Up to 64GB</li> <li>• 2 260-pin SO-DIMM Socket</li> </ul>
<b>I/O Interface</b>	
Serial	3 COM RS-232/422/485 (ESD 8kV)
USB	6 External USB 3.2 (External)
Isolated DIO	32 Isolated DIO : 16 DI, 16 DO
LED	Power, HDD
SIM Card	2 External Nano SIM Card Socket
SD Card	1 External Micro SD Card Socket
<b>Expansion</b>	
Mini PCIe	1 Mini PCIe Socket for PCIe/USB/SIM Card/mSATA
PCI/PCIe	1 PCI Slot
M.2	<ul style="list-style-type: none"> <li>• 1 M.2 Key B Socket (3042/3052)</li> <li>• 1 M.2 Key E Socket (2230)</li> </ul>
SUMIT A, B	2 SUMIT Slot (Optional)
<b>Graphics</b>	
Graphics Processor	<ul style="list-style-type: none"> <li>• Intel® UHD Graphics 630</li> <li>• Independent MXM Graphics : By request</li> <li>• MXM Graphics TDP : 50W</li> </ul>
Interface	Up to 7 independent displays : <ul style="list-style-type: none"> <li>• 1 VGA : Up to 1920 x 1200 @ 60Hz</li> <li>• 1 DVI-D : Up to 1920 x 1200 @ 60Hz</li> <li>• 2 DisplayPort : Up to 4096 x 2304 @ 60Hz</li> <li>• 4 DisplayPort : Up to 7680 x 4320 @ 60Hz (By requested MXM)</li> </ul>
<b>Storage</b>	
SATA	2 SATA III (6Gbps) support S/W RAID 0, 1
mSATA	1 SATA III (Mini PCIe Type, 6Gbps)
M.2	<ul style="list-style-type: none"> <li>• 1 M.2 Key B Socket (2280)</li> <li>• 1 M.2 Key M Socket (2280)</li> </ul>
Storage Device	<ul style="list-style-type: none"> <li>• 1 Micro SD Card Socket, Push-in/Push-out Ejector</li> <li>• 2 Front-access 2.5" SSD/HDD Tray</li> </ul>

<b>Audio</b>	
Audio Codec	Realtek ALC888S-VD, 7.1 Channel HD Audio
Audio Interface	1 Mic-in, 1 Line-out
<b>Ethernet</b>	
LAN 1	Intel® I219LM GigE LAN supports iAMT 14.0
LAN 2	Intel® I210 GigE LAN
<b>Power</b>	
Input Voltage	9V to 50V, DC-in
Power Interface	3-pin Terminal Block : V+, V-, Frame Ground
Ignition Control	16-mode Software Ignition Control
Remote Switch	3-pin Terminal Block : On, Off, IGN
Surge Protection	Up to 80V/1ms Transient Power
<b>Others</b>	
TPM	Infineon SLB9665 supports TPM 2.0, LPC interface
Watchdog Timer	Reset : 1 to 255 sec./min. per step
Smart Management	Wake on LAN, PXE supported
HW Monitor	Monitoring temperature, voltages. Auto throttling control when CPU overheats.
<b>Software Support</b>	
OS	Windows 10, Linux
<b>Mechanical</b>	
Dimension (W x D x H)	280.0mm x 215.0mm x 79.1mm (11.02" x 8.46" x 3.11")
Weight	4.9 kg (10.80 lbs)
Mounting	<ul style="list-style-type: none"> <li>• Wallmount by mounting bracket</li> <li>• DIN Rail Mount (Optional)</li> <li>• 2U Rackmount (Optional)</li> </ul>
<b>Environment</b>	
Operating Temperature	<b>35W TDP CPU</b> : -25°C to 55°C (-13°F to 131°F) <b>65W TDP CPU</b> : -25°C to 45°C (-13°F to 113°F)
Storage Temperature	-40°C to 85°C (-40°F to 185°F)
Humidity	5% to 95% humidity, non-condensing
Relative Humidity	95% @55°C
Shock	<ul style="list-style-type: none"> <li>• IEC 60068-2-27</li> <li>• SSD : 50G @ wallmount, Half-sine, 11ms</li> </ul>
Vibration	<ul style="list-style-type: none"> <li>• IEC 60068-2-64</li> <li>• SSD : 5Grms, 5Hz to 500Hz, 3 Axis</li> </ul>
EMC	CE, FCC, EN50155, EN50121-3-2

### 1.3.3 Specifications of EVS-2010F

<b>System</b>	
Processor	LGA 1200 Socket supports 10th Gen Intel® Xeon®/Core™ i9/i7/i5/i3 Processor (Comet Lake-S)
Chipset	Intel® W480E
BIOS	AMI
SIO	IT8786E
Memory	<ul style="list-style-type: none"> <li>• 2 DDR4 2933MHz</li> <li>• Up to 64GB</li> <li>• 2 260-pin SO-DIMM Socket</li> </ul>
<b>I/O Interface</b>	
Serial	3 COM RS-232/422/485 (ESD 8kV)
USB	6 External USB 3.2 (External)
Isolated DIO	32 Isolated DIO : 16 DI, 16 DO
LED	Power, HDD
SIM Card	2 External Nano SIM Card Socket
SD Card	1 External Micro SD Card Socket
<b>Expansion</b>	
Mini PCIe	1 Mini PCIe Socket for PCIe/USB/SIM Card/mSATA
PCI/PCIe	1 PCIe x4 Slot
M.2	<ul style="list-style-type: none"> <li>• 1 M.2 Key B Socket (3042/3052)</li> <li>• 1 M.2 Key E Socket (2230)</li> </ul>
SUMIT A, B	2 SUMIT Slot (Optional)
<b>Graphics</b>	
Graphics Processor	<ul style="list-style-type: none"> <li>• Intel® UHD Graphics 630</li> <li>• Independent MXM Graphics : By request</li> <li>• MXM Graphics TDP : 80W to 150W</li> </ul>
Interface	Up to 7 independent displays : <ul style="list-style-type: none"> <li>• 1 VGA : Up to 1920 x 1200 @ 60Hz</li> <li>• 1 DVI-D : Up to 1920 x 1200 @ 60Hz</li> <li>• 2 DisplayPort : Up to 4096 x 2304 @ 60Hz</li> <li>• 4 DisplayPort : Up to 7680 x 4320 @ 60Hz (By requested MXM)</li> </ul>
<b>Storage</b>	
SATA	2 SATA III (6Gbps) support S/W RAID 0, 1
mSATA	1 SATA III (Mini PCIe Type, 6Gbps)
M.2	<ul style="list-style-type: none"> <li>• 1 M.2 Key B Socket (2280)</li> <li>• 1 M.2 Key M Socket (2280)</li> </ul>
Storage Device	<ul style="list-style-type: none"> <li>• 1 Micro SD Card Socket, Push-in/Push-out Ejector</li> <li>• 2 Front-access 2.5" SSD/HDD Tray</li> </ul>

<b>Audio</b>	
Audio Codec	Realtek ALC888S-VD, 7.1 Channel HD Audio
Audio Interface	1 Mic-in, 1 Line-out
<b>Ethernet</b>	
LAN 1	Intel® I219LM GigE LAN supports iAMT 14.0
LAN 2	Intel® I210 GigE LAN
<b>Power</b>	
Input Voltage	<ul style="list-style-type: none"> <li>• 9V to 50V, DC-in</li> <li>• 20V to 50V, DC-in (For MXM module &gt;120W)</li> </ul>
Power Interface	3-pin Terminal Block : V+, V-, Frame Ground
Ignition Control	16-mode Software Ignition Control
Remote Switch	3-pin Terminal Block : On, Off, IGN
Surge Protection	Up to 80V/1ms Transient Power
<b>Others</b>	
TPM	Infineon SLB9665 supports TPM 2.0, LPC interface
Watchdog Timer	Reset : 1 to 255 sec./min. per step
Smart Management	Wake on LAN, PXE supported
HW Monitor	Monitoring temperature, voltages. Auto throttling control when CPU overheats.
<b>Software Support</b>	
OS	Windows 10, Linux
<b>Mechanical</b>	
Dimension (W x D x H)	280.0mm x 215.0mm x 86.5mm (11.02" x 8.46" x 3.41")
Weight	5 kg (11.02 lbs)
Mounting	<ul style="list-style-type: none"> <li>• Wallmount by mounting bracket</li> <li>• DIN Rail Mount (Optional)</li> <li>• 2U Rackmount (Optional)</li> </ul>
<b>Environment</b>	
Operating Temperature	<b>35W TDP CPU</b> : -25°C to 55°C (-13°F to 131°F) <b>65W TDP CPU</b> : -25°C to 45°C (-13°F to 113°F)
Storage Temperature	-40°C to 85°C (-40°F to 185°F)
Humidity	5% to 95% humidity, non-condensing
Relative Humidity	95% @55°C
Shock	<ul style="list-style-type: none"> <li>• IEC 60068-2-27</li> <li>• SSD : 50G @ wallmount, Half-sine, 11ms</li> </ul>
Vibration	<ul style="list-style-type: none"> <li>• IEC 60068-2-64</li> <li>• SSD : 5Grms, 5Hz to 500Hz, 3 Axis</li> </ul>
EMC	CE, FCC, EN50155, EN50121-3-2

### 1.3.4 Specifications of EVS-2001F

<b>System</b>	
Processor	LGA 1200 Socket supports 10th Gen Intel® Xeon®/Core™ i9/i7/i5/i3 Processor (Comet Lake-S)
Chipset	Intel® W480E
BIOS	AMI
SIO	IT8786E
Memory	<ul style="list-style-type: none"> <li>• 2 DDR4 2933MHz</li> <li>• Up to 64GB</li> <li>• 2 260-pin SO-DIMM Socket</li> </ul>
<b>I/O Interface</b>	
Serial	3 COM RS-232/422/485 (ESD 8kV)
USB	6 External USB 3.2 (External)
Isolated DIO	32 Isolated DIO : 16 DI, 16 DO
LED	Power, HDD
SIM Card	2 External Nano SIM Card Socket
SD Card	1 External Micro SD Card Socket
<b>Expansion</b>	
Mini PCIe	1 Mini PCIe Socket for PCIe/USB/SIM Card/mSATA
PCI/PCIe	1 PCI Slot
M.2	<ul style="list-style-type: none"> <li>• 1 M.2 Key B Socket (3042/3052)</li> <li>• 1 M.2 Key E Socket (2230)</li> </ul>
SUMIT A, B	2 SUMIT Slot (Optional)
<b>Graphics</b>	
Graphics Processor	<ul style="list-style-type: none"> <li>• Intel® UHD Graphics 630</li> <li>• Independent MXM Graphics : By request</li> <li>• MXM Graphics TDP : 80W to 150W</li> </ul>
Interface	Up to 7 independent displays : <ul style="list-style-type: none"> <li>• 1 VGA : Up to 1920 x 1200 @ 60Hz</li> <li>• 1 DVI-D : Up to 1920 x 1200 @ 60Hz</li> <li>• 2 DisplayPort : Up to 4096 x 2304 @ 60Hz</li> <li>• 4 DisplayPort : Up to 7680 x 4320 @ 60Hz (By requested MXM)</li> </ul>
<b>Storage</b>	
SATA	2 SATA III (6Gbps) support S/W RAID 0, 1
mSATA	1 SATA III (Mini PCIe Type, 6Gbps)
M.2	<ul style="list-style-type: none"> <li>• 1 M.2 Key B Socket (2280)</li> <li>• 1 M.2 Key M Socket (2280)</li> </ul>
Storage Device	<ul style="list-style-type: none"> <li>• 1 Micro SD Card Socket, Push-in/Push-out Ejector</li> <li>• 2 Front-access 2.5" SSD/HDD Tray</li> </ul>



<b>Audio</b>	
Audio Codec	Realtek ALC888S-VD, 7.1 Channel HD Audio
Audio Interface	1 Mic-in, 1 Line-out
<b>Ethernet</b>	
LAN 1	Intel® I219LM GigE LAN supports iAMT 14.0
LAN 2	Intel® I210 GigE LAN
<b>Power</b>	
Input Voltage	<ul style="list-style-type: none"> <li>• 9V to 50V, DC-in</li> <li>• 20V to 50V, DC-in (For MXM module &gt;120W)</li> </ul>
Power Interface	3-pin Terminal Block : V+, V-, Frame Ground
Ignition Control	16-mode Software Ignition Control
Remote Switch	3-pin Terminal Block : On, Off, IGN
Surge Protection	Up to 80V/1ms Transient Power
<b>Others</b>	
TPM	Infineon SLB9665 supports TPM 2.0, LPC interface
Watchdog Timer	Reset : 1 to 255 sec./min. per step
Smart Management	Wake on LAN, PXE supported
HW Monitor	Monitoring temperature, voltages. Auto throttling control when CPU overheats.
<b>Software Support</b>	
OS	Windows 10, Linux
<b>Mechanical</b>	
Dimension (W x D x H)	280.0mm x 215.0mm x 86.5mm (11.02" x 8.46" x 3.41")
Weight	5 kg (11.02 lbs)
Mounting	<ul style="list-style-type: none"> <li>• Wallmount by mounting bracket</li> <li>• DIN Rail Mount (Optional)</li> <li>• 2U Rackmount (Optional)</li> </ul>
<b>Environment</b>	
Operating Temperature	<b>35W TDP CPU</b> : -25°C to 55°C (-13°F to 131°F) <b>65W TDP CPU</b> : -25°C to 45°C (-13°F to 113°F)
Storage Temperature	-40°C to 85°C (-40°F to 185°F)
Humidity	5% to 95% humidity, non-condensing
Relative Humidity	95% @55°C
Shock	<ul style="list-style-type: none"> <li>• IEC 60068-2-27</li> <li>• SSD : 50G @ wallmount, Half-sine, 11ms</li> </ul>
Vibration	<ul style="list-style-type: none"> <li>• IEC 60068-2-64</li> <li>• SSD : 5Grms, 5Hz to 500Hz, 3 Axis</li> </ul>
EMC	CE, FCC, EN50155, EN50121-3-2

## 1.4 Supported CPU List

Series	CPU	Cores	TDP	Cache	Max. Frequency	ECC Memory
Intel® Xeon®	W-1290TE	10	35W	20M	Up to 4.5GHz	Y
	W-1270TE	8	35W	16M	Up to 4.4GHz	Y
	W-1250TE	6	35W	12M	Up to 3.8GHz	Y
Intel® Core™	i9-10900E	10	65W	20M	Up to 4.7GHz	NA
	i9-10900TE	10	35W	20M	Up to 4.5GHz	NA
	i7-10700E	8	65W	16M	Up to 4.5GHz	NA
	i7-10700TE	8	35W	16M	Up to 4.4GHz	NA
	i5-10500E	6	65W	12M	Up to 4.2GHz	NA
	i5-10500TE	6	35W	12M	Up to 3.7GHz	NA
	i3-10100E	4	65W	6M	Up to 3.8GHz	Y
	i3-10100TE	4	35W	6M	Up to 3.6GHz	Y

# 1.5 Mechanical Dimension

## 1.5.1 Dimensions of EVS-2000

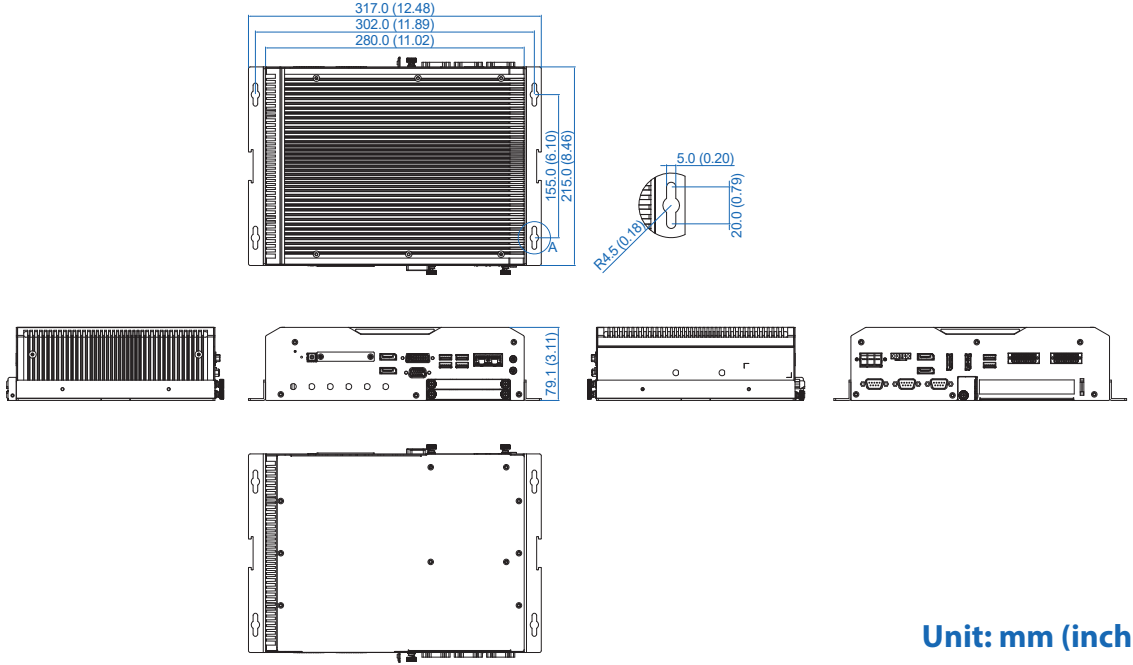

## 1.5.2 Dimensions of EVS-2000F

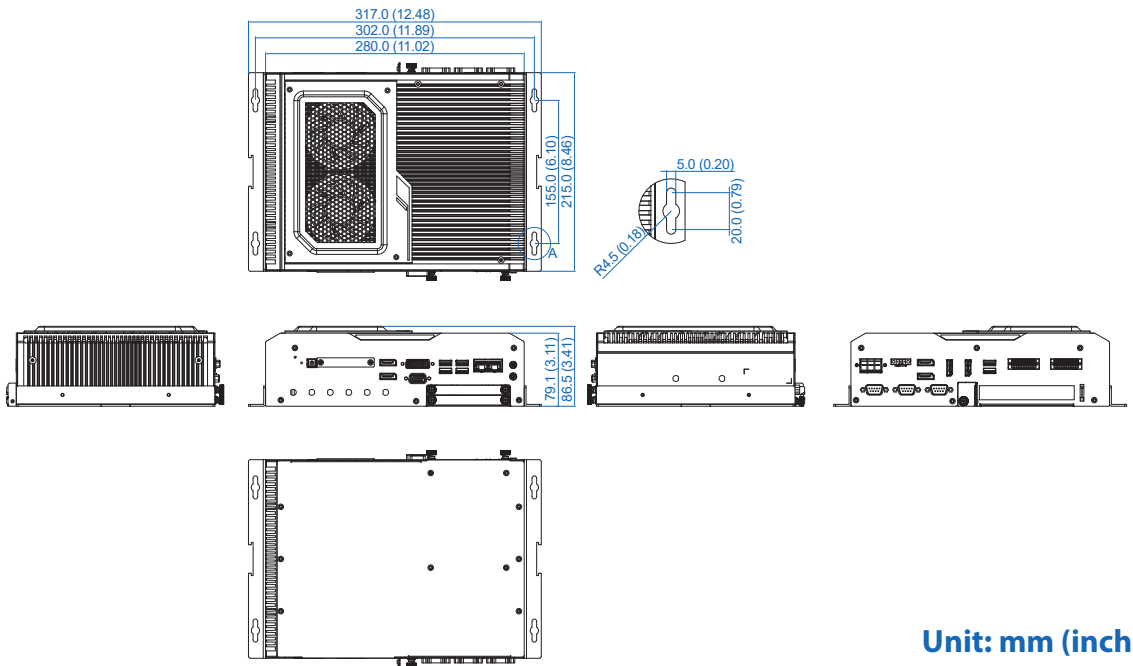

# 2

## GETTING TO KNOW YOUR EVS-2000

### 2.1 Packing List of EVS-2000/2000F

#### 2.1.1 Packing List of EVS-2000

Item	Description	Qty
1	EVS-2000 Expandable Fanless Embedded System (According to the configuration of you order, the EVS-2000 series may contain SSD/HDD and DDR4 SO-DIMM. Please verify these items if necessary.)	1

Item	Description	Outlook	Usage	P/N	Qty
1	PHILLPIS M2.5x6L,Ni		Mini PCIe module card	53-2426906-30B	1
2	PHILLPIS M3x4L,Ni+Ny		M.2	53-2426204-80B	4
3	Terminal block 3-pin (7.62mm)		DC-IN	51-2611R03-S1N	1
4	Terminal block 3-pin (3.5mm)		Switch	51-2211R03-S1A	1
5	Terminal block 20-pin (2.54mm)		Isolated DIO/GPIO	51-2112R20-S1D	2
6	Wall-mounting bracket		Mount	62-00P0047-000	2
7	PHILLPIS F-M3x4L		SSD/HDD	53-M000450-301	4
8	PHILLPIS I-M3x6L		Fasten Wall mount	53-2450000-218	4
9	Thermal grease		CPU	53-4000342-203	1

## 2.1.2 Packing List of EVS-2000F

Item	Description	Qty
1	EVS-2000F Expandable Embedded System (According to the configuration of you order, the EVS-2000F series may contain SSD/ HDD and DDR4 SO-DIMM. Please verify these items if necessary.)	1

Item	Description	Outlook	Usage	P/N	Qty
1	PHILLPIS M2.5x6L,Ni		Mini PCIe module card	53-2426906-30B	1
2	PHILLPIS M3x4L,Ni+Ny		M.2	53-2426204-80B	4
3	Terminal block 3-pin (7.62mm)		DC-IN	51-2611R03-S1N	1
4	Terminal block 3-pin (3.5mm)		Switch	51-2211R03-S1A	1
5	Terminal block 20-pin (2.54mm)		Isolated DIO/GPIO	51-2112R20-S1D	2
6	Wall-mounting bracket		Mount	62-00P0047-000	2
7	PHILLPIS F-M3x4L		SSD/HDD	53-M000450-301	4
8	PHILLPIS I-M3x6L		Fasten Wall mount	53-2450000-218	4
9	Thermal grease		CPU	53-4000342-203	1

## 2.2 Front Panel I/O & Functions

In Vecow EVS-2000 series family, all I/O connectors are located on front panel and rear panel. Most of the general connections to computer device, such as USB, LAN Jack, Audio, Display, VGA, DVI-D and any additional storage, are placed on the front panel.

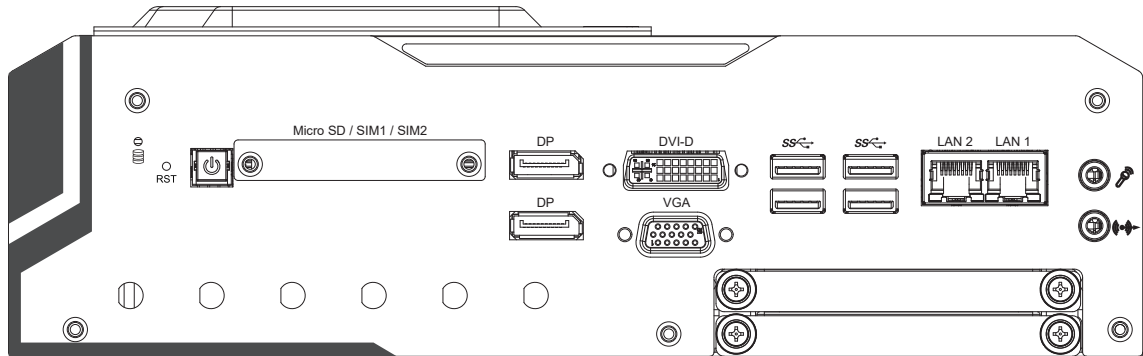

### 2.2.1 Power Button and Power LED

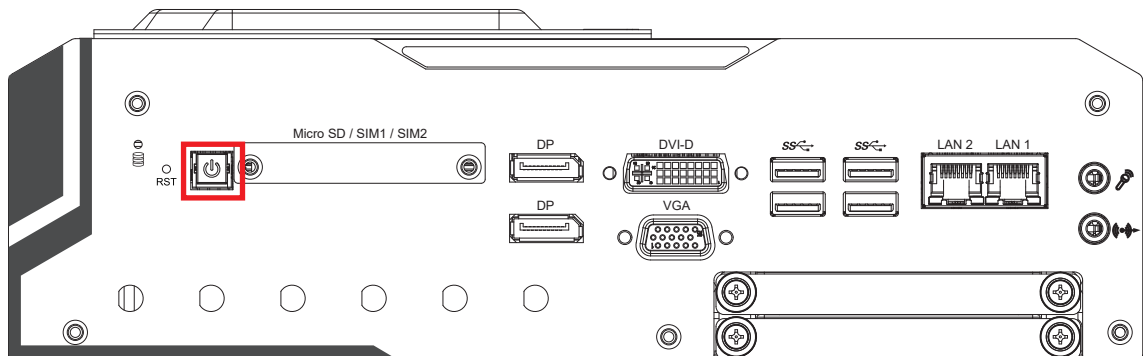

The Power Button is a non-latched switch with dual color LED indication. It indicates power status : S0, S3 and S5. More detail LED indications are listed as follows :

LED Color	Power Status	System Status
Solid Blue	S0	System working
Solid Orange	S3, S5	Suspend to RAM, System off with standby power

To power on the system, press the power button and then the blue LED is lightened. To power off the system, you can either command shutdown by OS operation, or just simply press the power button.

If system error, you can just press the power button for 4 seconds to shut down the machine directly. Please do note that a 4-second interval between each 2 power-on/power-off operation is necessary in normal working status. (For example, once turning off the system, you have to wait for 4 seconds to initiate another power-on operation.)

## 2.2.2 Reset Tact Switch

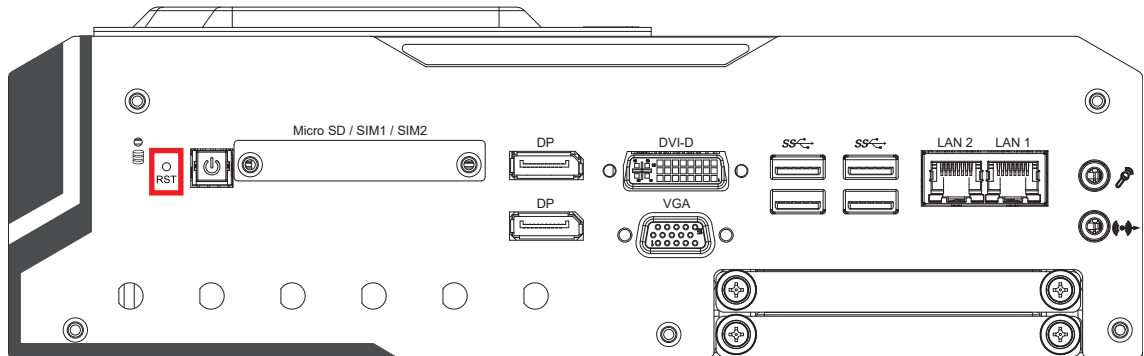

It is a hardware reset switch. Use this switch to reset the system without power off the system. Press the Reset Switch for a few seconds, and then reset will be enabled.

## 2.2.3 SIM1/SIM2

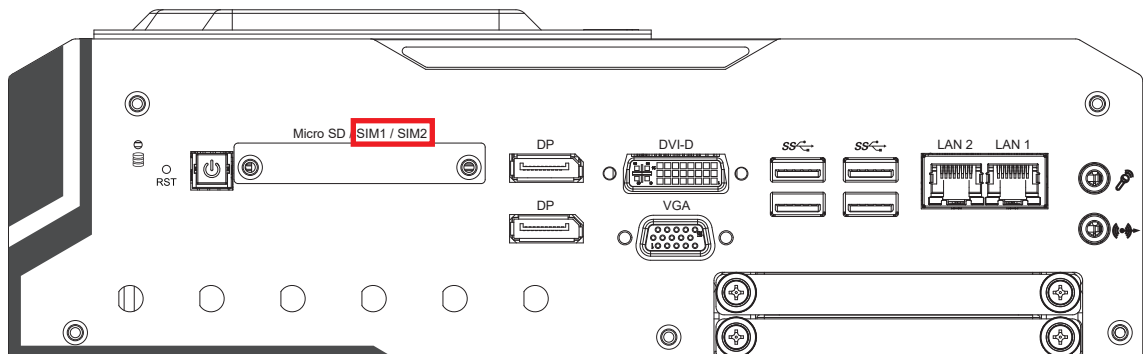

SIM1/SIM2 mapping table as below table :

SIM Slot	Source Connector
SIM1	M2B_CN1
SIM2	MPCIE1

Note :

The Nano SIM card sockets do not support hot-plug. Please make sure to unplug the system power before inserting the Nano SIM card(s).

## 2.2.4 HDD LED Indicator

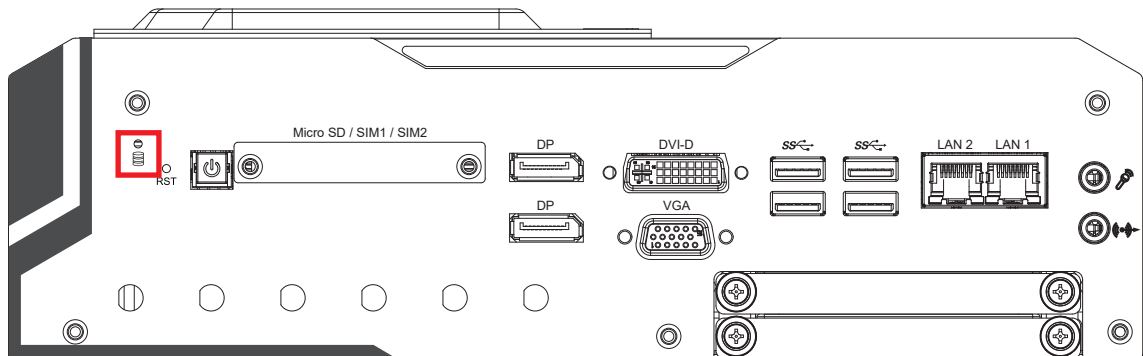

**HDD LED/Yellow** : A Hard Disk. If the LED is on, it indicates that the system's storage is functional. If it is off, it indicates that the system's storage is not functional. If it is flashing, it indicates data access activities.

LED Color	Indication	System Status
Yellow	HDD	<ul style="list-style-type: none"> <li>On/Off : Storage status, function or not</li> <li>Twinkling : Data transferring</li> </ul>

## 2.2.5 DVI-D Connector

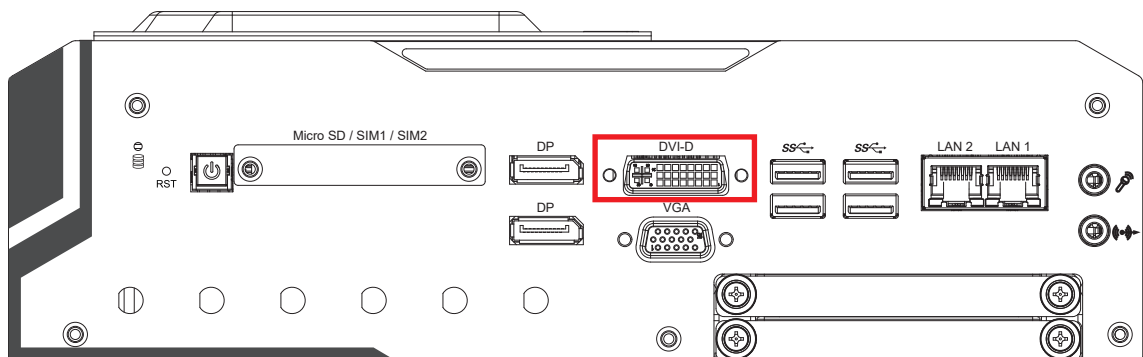

The DVI-D connector on the front panel supports DVI display. This connector can either output DVI signal. The DVI output mode supports up to 1920 x 1200 resolution and output mode supports up to 1920 x 1200 resolutions. The DVI is automatically selected according to the connected display. You will need a DVI-D cable when connecting to a display device.



## 2.2.6 VGA Connector

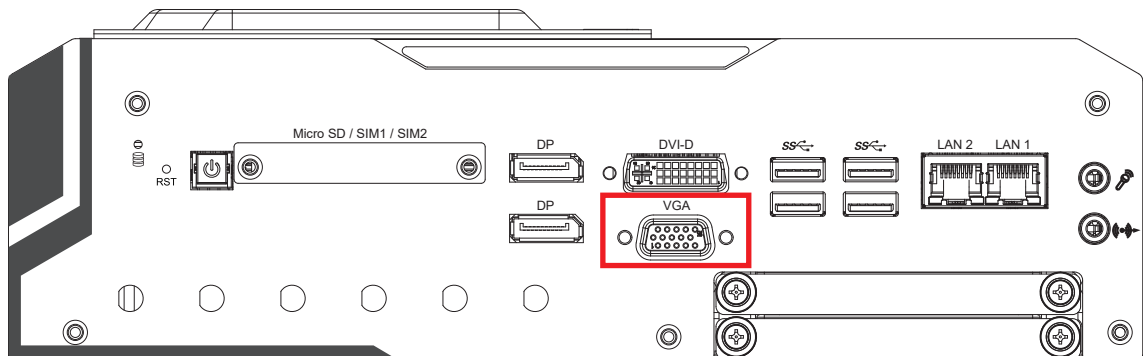

The VGA output mode supports up to 1920 x 1200 resolutions. The pin assignments of the VGA connector are shown below.

Pin No.	Description	Pin No.	Description
1	Red Color Signal	9	VCC
2	Green Color Signal	10	Ground
3	Blue Color Signal	11	NC
4	NC	12	DDC-DATA
5	Ground	13	H-Sync.
6	VGA Detect	14	V-Sync.
7	Ground	15	DDC-CLK
8	Ground		

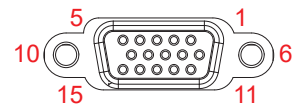

## 2.2.7 DisplayPort

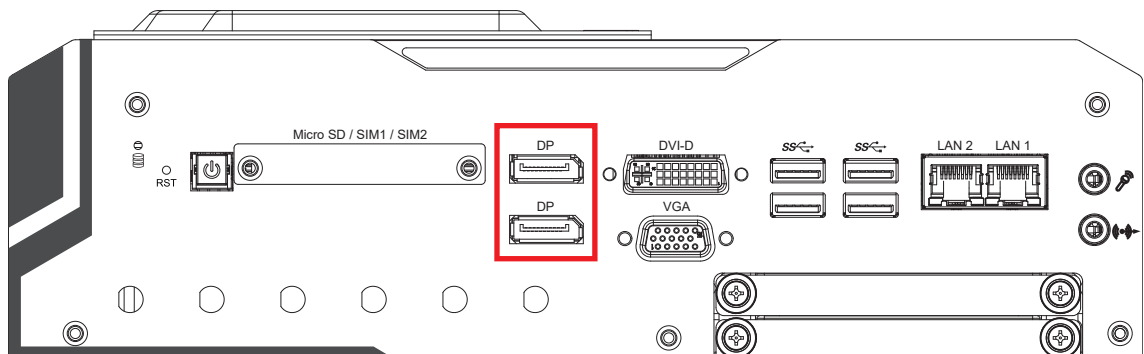

Onboard Display Port supports auxiliary channel dual mode, and the connection supports up to 4096 x 2304 resolution at 60Hz.

Multi-Stream Transport Display Resolutions Table :

Multi-Stream Transport Display	Max. Resolution
Two panel Displays concurrently	4096 x 2304 @60Hz

## 2.2.8 USB 3.0

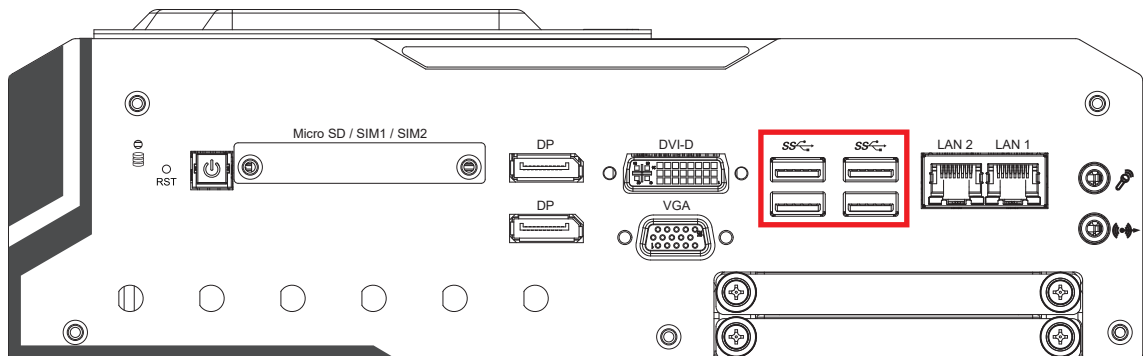

There are 4 USB 3.0 connections available supporting up to 5GB per second data rate in the front side of EVS-2000. It is also compliant with the requirements of Speed (SS), High Speed (HS), Full Speed (FS) and Low Speed (LS).

## 2.2.9 Ethernet Port

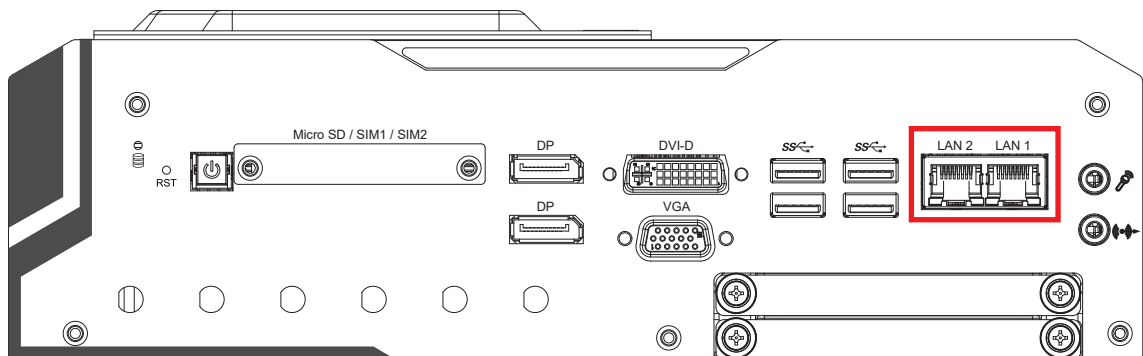

There are dual 8-pin RJ-45 jacks supporting 10/100/1000 Mbps Ethernet connections in the front side. LAN 1 is powered by Intel® i219 Ethernet Phy and LAN 2 is powered by Intel® I210 Ethernet engine. When both LAN 1 and LAN 2 work at normal status, iAMT 11.0 function is enabled.

Using suitable RJ-45 cable, you can connect the system to a computer or to any other devices with Ethernet connection; for example, a hub or a switch. Moreover, both LAN 1 and LAN 2 support Wake on LAN and Pre-boot functions. The pin-outs of LAN 1 and LAN 2 are listed as follows :

Pin No.	10/100 Mbps	1000"
1	E_TX+	MDI0_P
2	E_TX-	MDI0_N
3	E_RX+	MDI1_P
4	----	MDI2_P
5	----	MDI2_N
6	E_RX-	MDI1_N
7	----	MDI3_P
8	----	MDI3_N

Each LAN port is supported by standard RJ-45 connector with LED indicators to present Active/Link/Speed status of the connection.

The LED indicator on the right bottom corner lightens in solid green when the cable is properly connected to a 100Mbps Ethernet network; The LED indicator on the right bottom corner lightens in solid orange when the cable is properly connected to a 1000Mbps Ethernet network; The left LED will keep twinkling/off when Ethernet data packets are being transmitted/received.

LED Location	LED Color	10Mbps	100Mbps	1000Mbps
Right	Green/ Orange	Off	Solid Green	Solid Orange
Left	Yellow	Flash Green	Flash Green	Flash Green

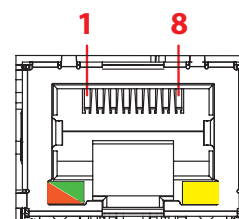

## 2.2.10 Audio Jack

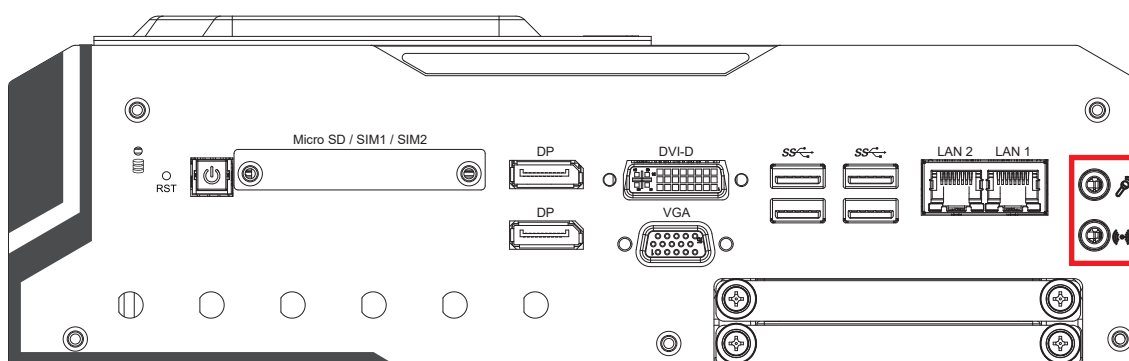

There are 2 audio connectors, Mic-in and Line-out, in the front side of EVS-2000. Onboard Realtek ALC888S-VD audio codec supports 7.1 channel HD audio and fully complies with Intel® High Definition Audio (Azalia) specifications.

To utilize the audio function in Windows platform, you need to install the corresponding drivers for both Intel® CM236 chipset and Realtek ALC888S-VD codec.

## 2.2.11 Micro SD card

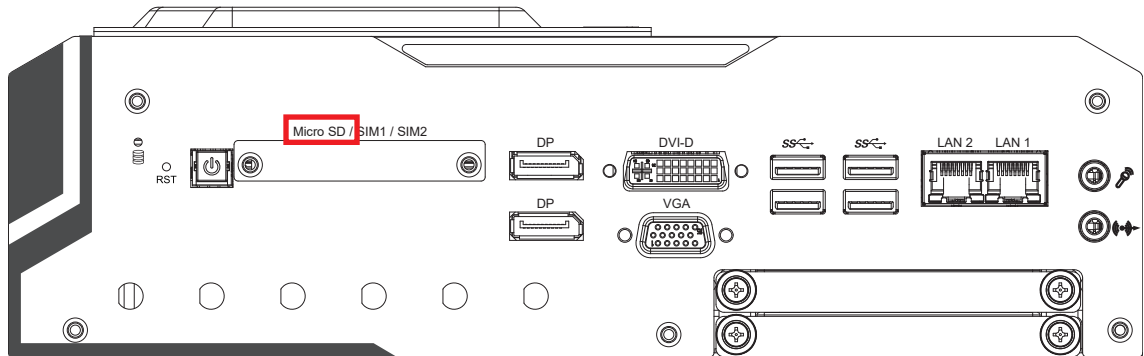

There is a micro sd card socket on the front panel.

The pin outs of micro sd port are listed as follows :

Pin No.	Description	Pin No.	Description
1	SD_DATA2	6	GND
2	SD_DATA3	7	SD_DATA0
3	SD_CMD	8	SD_DATA1
4	SD_PWR (+V3.3)	9	SD_WP
5	SD_CLK	10	SD_DET#

## 2.2.12 SSD/HDD Tray

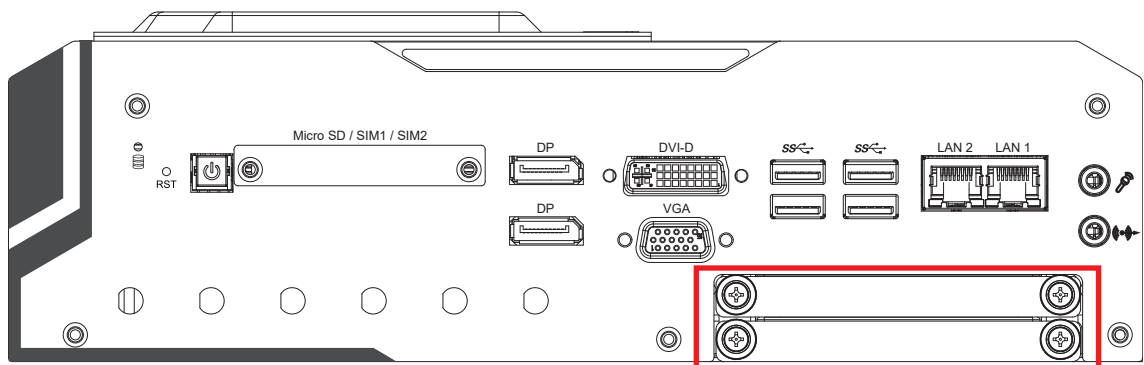

There are 2 front-access 2.5" SSD/HDD trays in the front side of EVS-2000.

Just trigger to open the SSD/HDD tray, up to 4TB is available.

## 2.3 Rear Panel I/O & Functions

### 2.3.1 Power Terminal Block

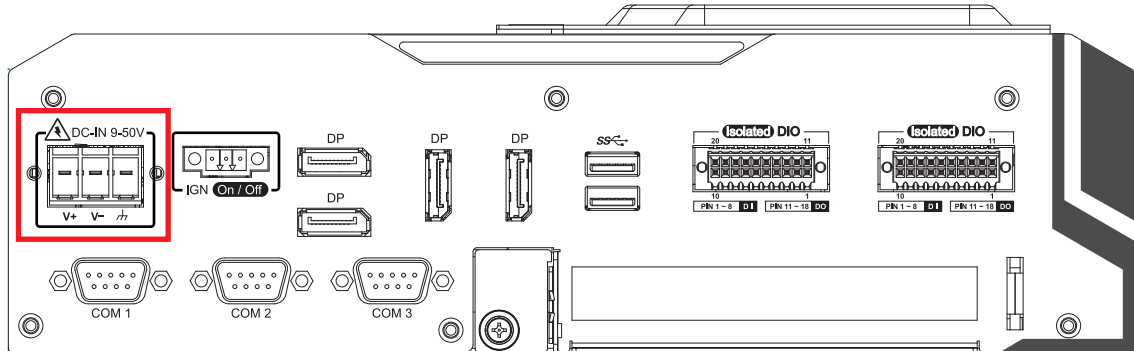

This system supports 9V to 50V DC power input by terminal block in the rear side. And the pin define is as below table.

Pin No.	Definition
1	V+
2	V-
3	Chassis Ground

### 2.3.2 Remote Power On/Off Switch & Ignition

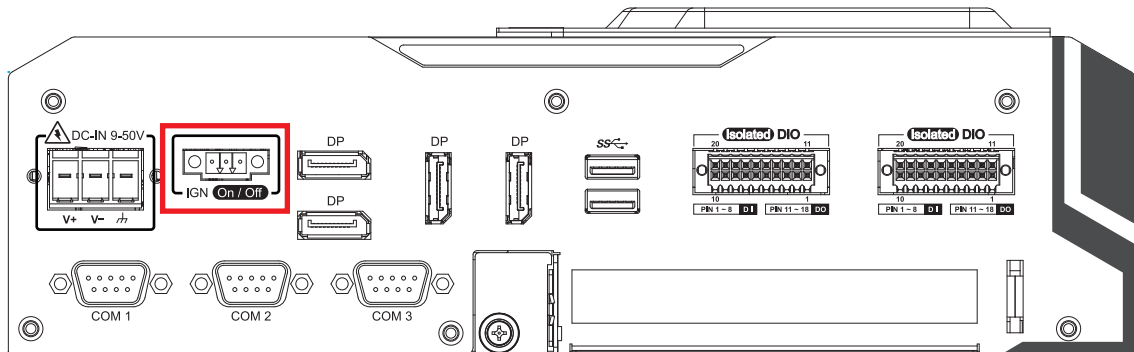

It is a 2-pin power-on or power-off switch through Phoenix Contact terminal block. You could turn on or off the system power by using this contact. This terminal block supports dual function of soft power-on/power-off (instant off or delay 4 second), and suspend mode.

Pin No.	Definition
1	Ignition
2	SW+
3	SW-

### 2.3.3 COM Ports

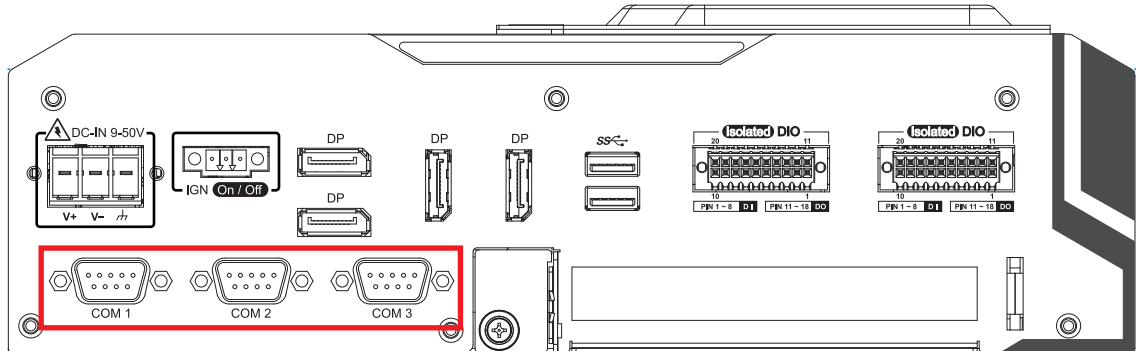

Serial port 1~4 (COM 1~4) can be configured for RS-232, RS-422, or RS-485 with auto flow control communication. The default definition of COM 1 to COM4 is RS-232; but if you want to change to RS-422 or RS-485, you can find the setting in BIOS.

BIOS Setting	Function
COM 1 COM 2 COM 3 COM 4	RS-232
	RS-422 (5-wire)
	RS-422 (9-wire)
	RS-485
	RS-485 w/z auto-flow control

The rear i/o D-SUB connector pin assignments are listed in the following table :

Serial Port	Pin No.	RS-232	RS-422 (5-wire)	RS-422 (9-wire)	RS-485 (3-wire)
1 to 4	1	DCD	TXD-	TXD-	DATA-
	2	RXD	TXD+	TXD+	DATA+
	3	TXD	RXD+	RXD+	-----
	4	DTR	RXD-	RXD-	-----
	5	GND	GND	GND	GND
	6	DSR	-----	RTS-	-----
	7	RTS	-----	RTS+	-----
	8	CTS	-----	CTS+	-----
	9	RI	-----	CTS-	-----

COM1 TO COM4 MB connector table :

COM Port	MB Connector	COM Port	MB Connector
COM 1	COM 1	COM 2	COM 2
COM 3	COM 3	COM 4	COM 4

COM3 & COM4 MB connector pin out :

CN	Pin No.	Signal Name	Pin No.	Signal Name
COM1 to COM4	1	NC	6	TXD
	2	GND	7	RTS
	3	RI	8	RXD
	4	DTR	9	DSR
	5	CTS	10	DCD

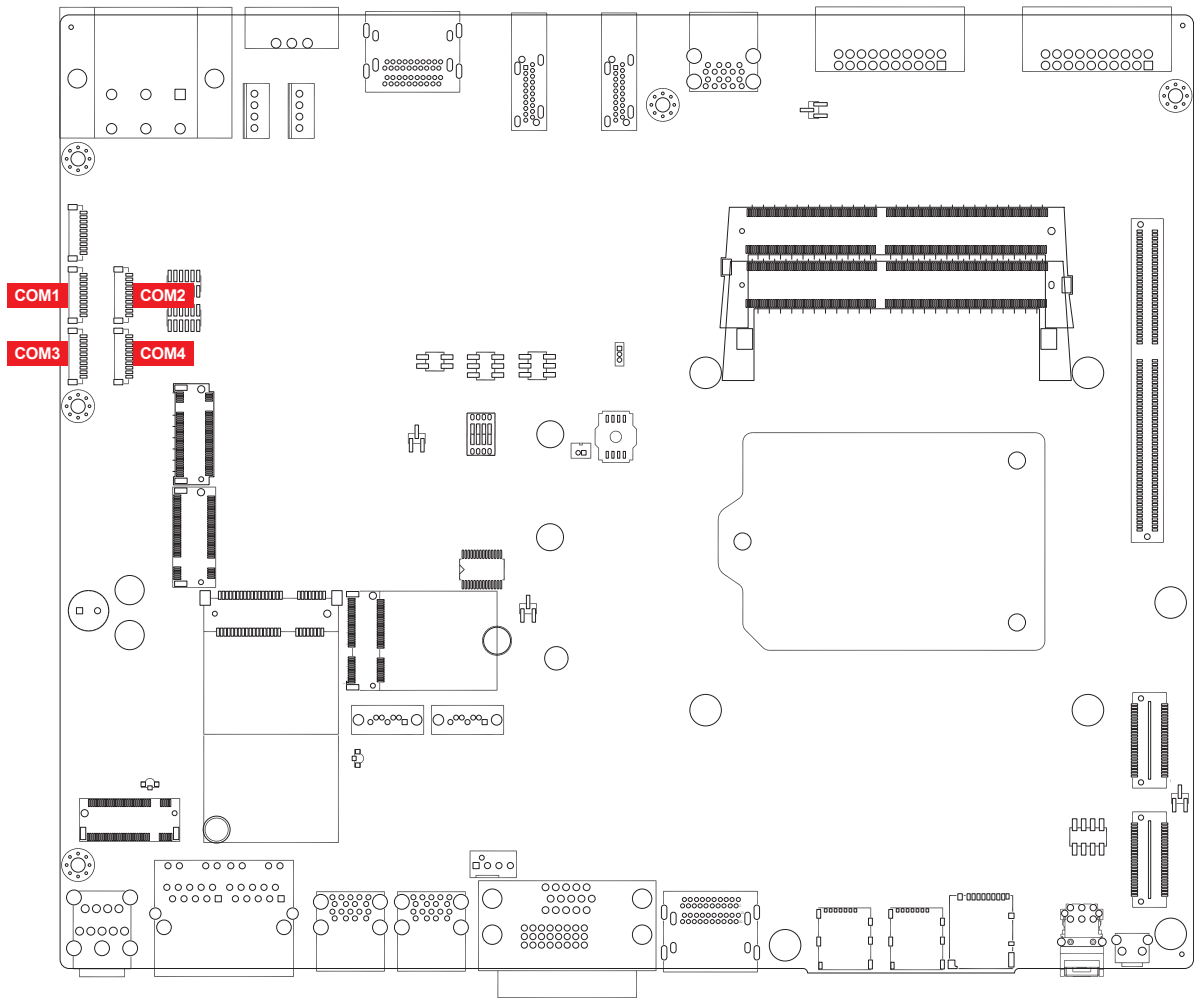

### 2.3.4 Rear USB 3.0

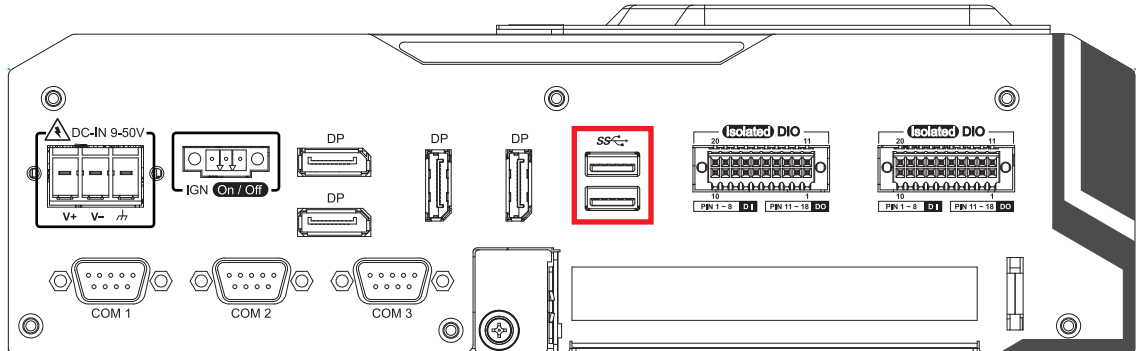

There are 2 USB 3.0 connections available supporting up to 5GB per second data rate in the rear side of EVS-2000. It is also compliant with the requirements of Super Speed (SS), High Speed (HS), Full Speed (FS) and Low Speed (LS).

### 2.3.5 DisplayPort

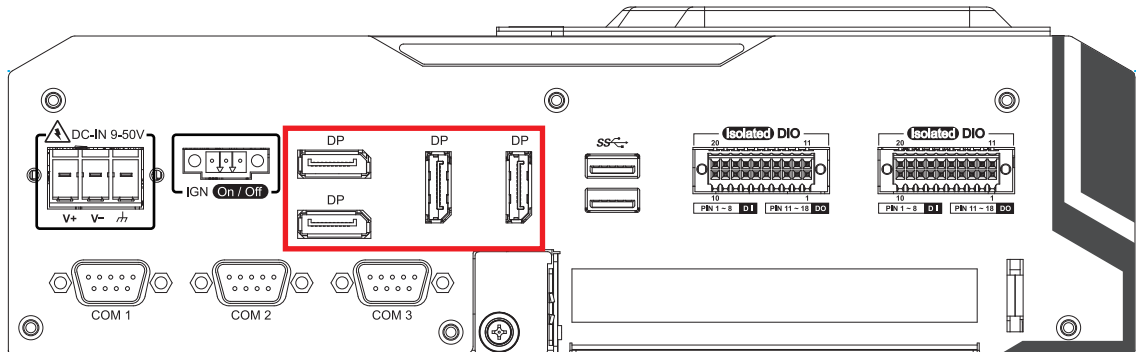

Onboard Display Port supports auxiliary channel dual mode, and the connection supports up to 7680 x 4320 resolution at 60Hz.

Multi-Stream Transport Display Resolutions Table :

Multi-Stream Transport Display	Max. Resolution
EVS-2000 Two panel Displays concurrently	7680 x 4320 @60Hz



## 2.3.6 Isolated DIO

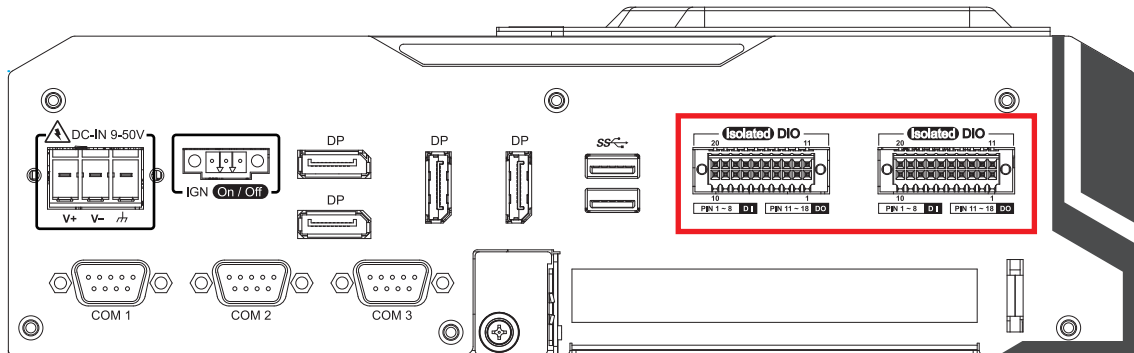

There is a 32-bit (16-bit DI, 16-bit DO) with 2 DIO connectors in the rear side. DI/DIO support NPN (sink) and PNP (Source) mode, Each DI channel is equipped with a photocoupler for isolated protection.

Each DO with isolator chip is configured by software for each DIO connector.

DO Safety-Related Certifications :

- 4242-VPK Basic Isolation per DIN V VDE V 0884-10 and DIN EN 61010-1
- 3-KVRMS Isolation for 1 minute per UL 1577
- CSA Component Acceptance Notice 5A, IEC 60950-1 and IEC 61010-1 End Equipment Standards
- GB4943.1-2011 CQC Certified

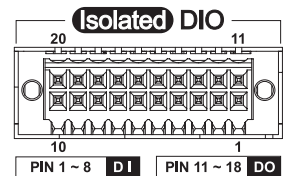

DIO Connectors pin out :

DIO	Pin No.	Definition	Function	Pin No.	Definition	Function
DIO1	1	EXT_IN8	DIO2_GPI0	11	EXT_OUT8	DIO2_GPO0
	2	EXT_IN9	DIO2_GPI1	12	EXT_OUT9	DIO2_GPO1
	3	EXT_IN10	DIO2_GPI2	13	EXT_OUT10	DIO2_GPO2
	4	EXT_IN11	DIO2_GPI3	14	EXT_OUT11	DIO2_GPO3
	5	EXT_IN12	DIO2_GPI4	15	EXT_OUT12	DIO2_GPO4
	6	EXT_IN13	DIO2_GPI5	16	EXT_OUT13	DIO2_GPO5
	7	EXT_IN14	DIO2_GPI6	17	EXT_OUT14	DIO2_GPO6
	8	EXT_IN15	DIO2_GPI7	18	EXT_OUT15	DIO2_GPO7
	9	+VDI_COM1	-	19	GND_ISO_DIO1	-
	10	GND_ISO_DIO1	-	20	+VDIO_EXT1 (6~48V Input)	-

DIO	Pin No.	Definition	Function	Pin No.	Definition	Function
DIO2	1	EXT_IN0	SIO_GPI80	11	EXT_OUT0	SIO_GPO70
	2	EXT_IN1	SIO_GPI81	12	EXT_OUT1	SIO_GPO71
	3	EXT_IN2	SIO_GPI82	13	EXT_OUT2	SIO_GPO72
	4	EXT_IN3	SIO_GPI83	14	EXT_OUT3	SIO_GPO73
	5	EXT_IN4	SIO_GPI84	15	EXT_OUT4	SIO_GPO74
	6	EXT_IN5	SIO_GPI85	16	EXT_OUT5	SIO_GPO75
	7	EXT_IN6	SIO_GPI86	17	EXT_OUT6	SIO_GPO76
	8	EXT_IN7	SIO_GPI87	18	EXT_OUT7	SIO_GPO77
	9	+VDI_COM	-	19	GND_ISO_DIO	-
	10	GND_ISO_DIO	-	20	+VDIO_EXT (6~48V Input)	-

### DI Reference Circuit :

Sink Mode (NPN)

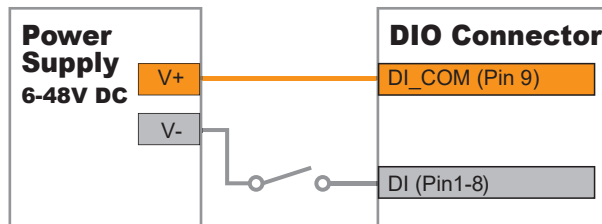

Source Mode (PNP)

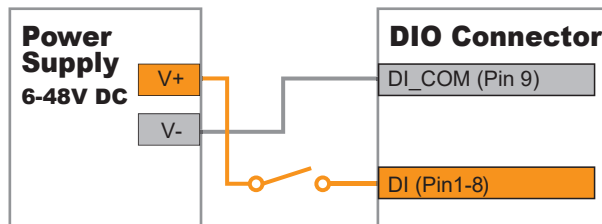

### DO Reference Circuit :

Sink Mode (NPN, Default)

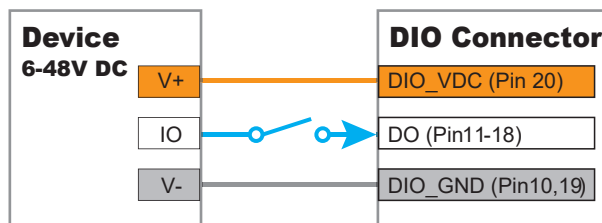

Source Mode (PNP)

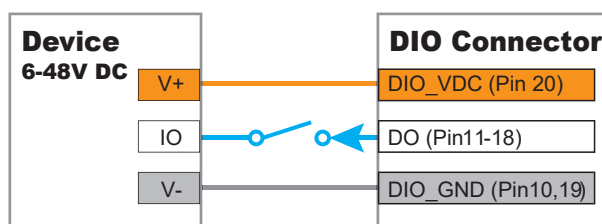

### 2.3.7 Add Card

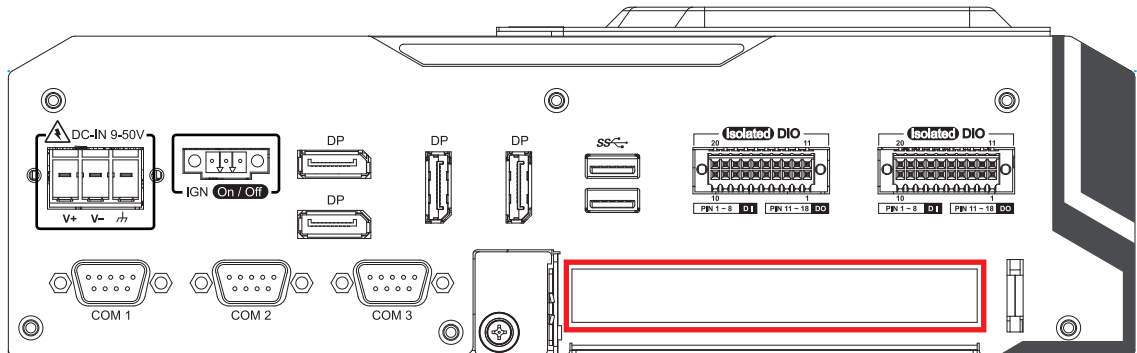

Optional for PCIe x4 FHHL add on card or PCI card.

## 2.4 Main Board Expansion Connectors

### 2.4.1 Inside View of EVS-2000 Main Board with Connector Location

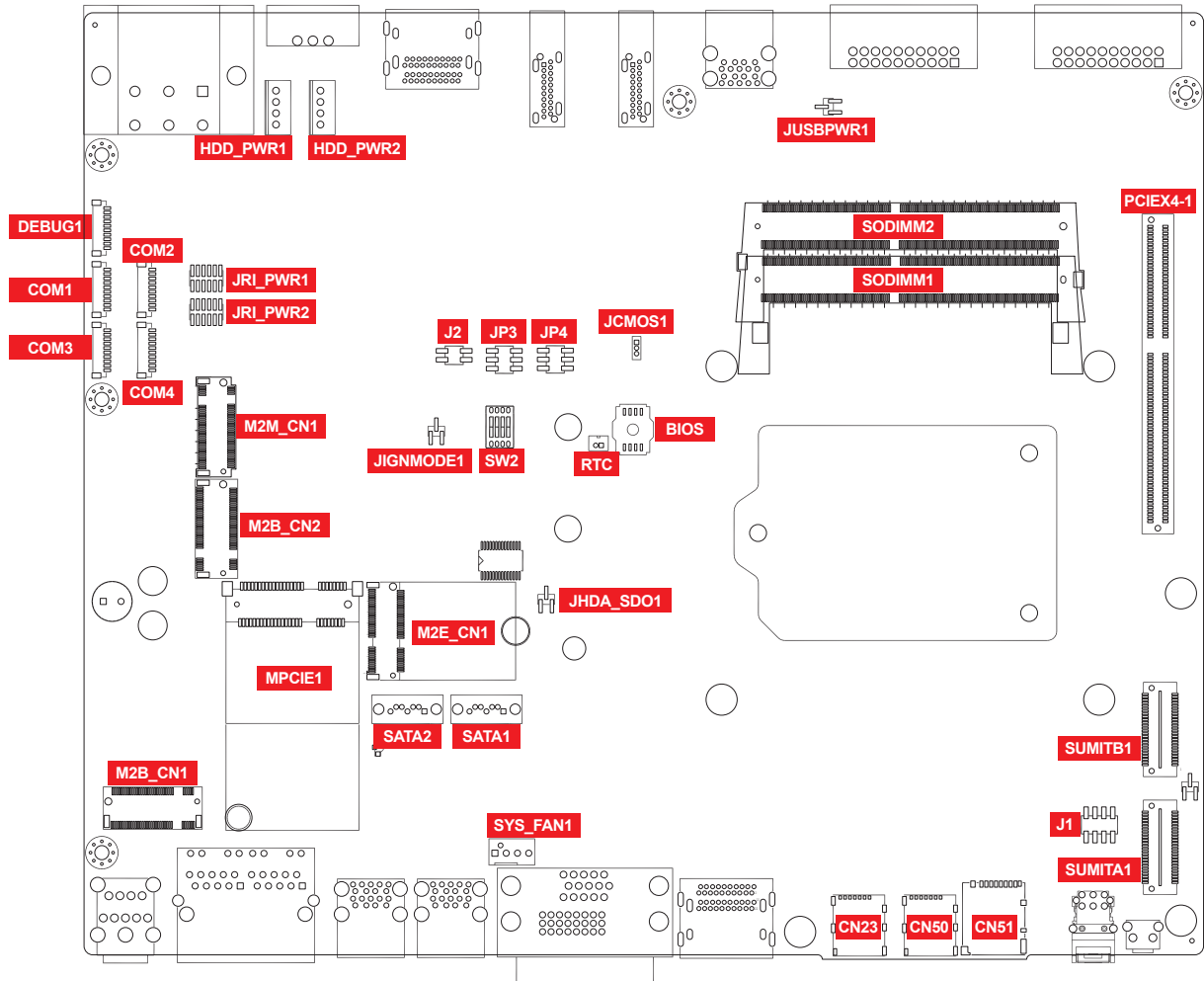

## 2.4.2 Miscellaneous Pin Header (J1)

### 2.0mm 2x4p header

This pin header can be used as a backup for following functions, such as hard drive LED indicator, reset button, power LED indicator, and power-on/off button, which already can be accessed by front panel and top panel. The pin-outs of miscellaneous port are listed in following table :

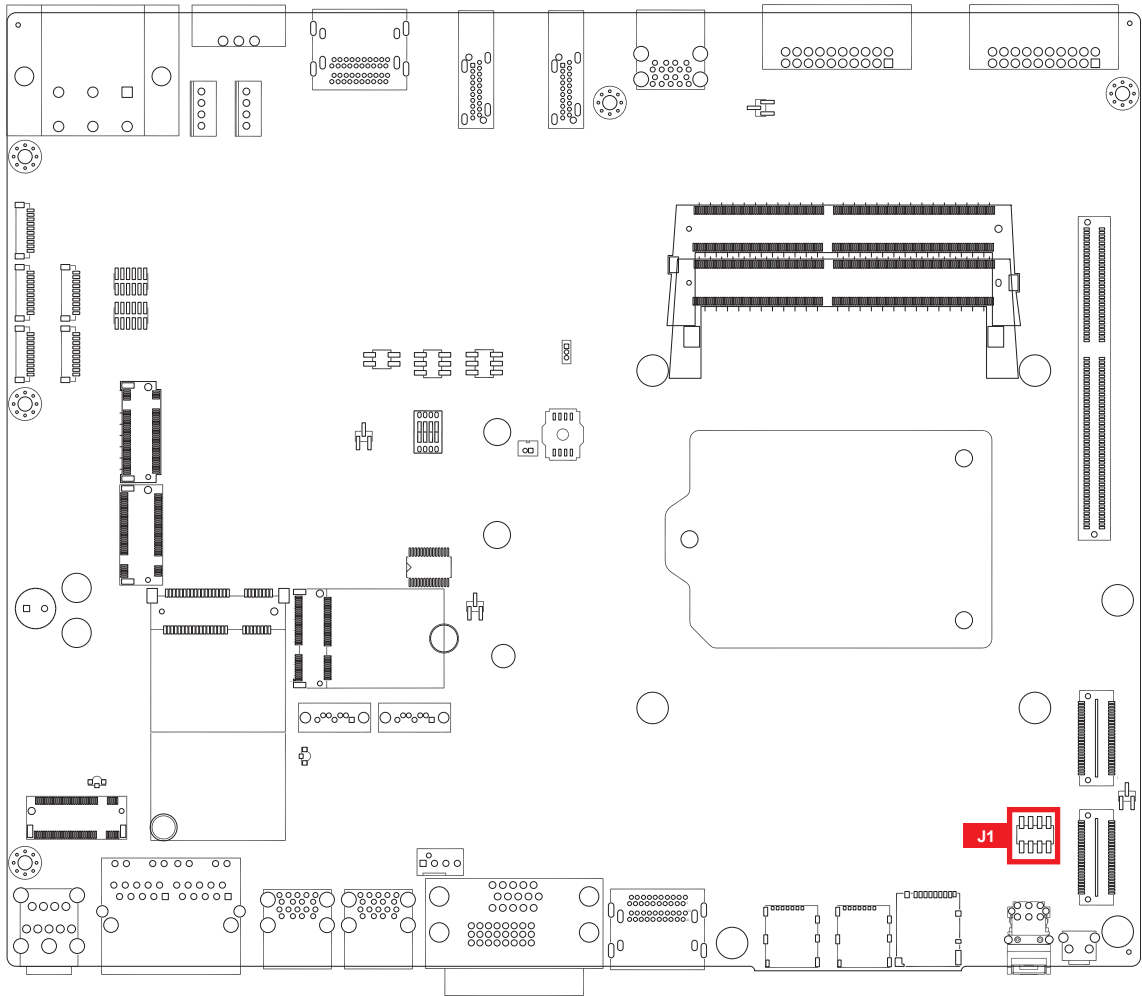

Group	Pin No.	Definition
HDD LED	1	HDD_LED_P
	3	HDD_LED_N
RESET BUTTON	5	FP_RST_BTN_N
	7	Ground
POWER LED	2	PWR_LED_P
	4	NC
POWER BUTTON	6	FP_PWR_BTN_P
		Ground

### 2.4.3 DDR4 Slot

There are 2 DDR4 channel onboard supporting DDR4 2400/2133 and up to 64GB. (Each channel 16GB)

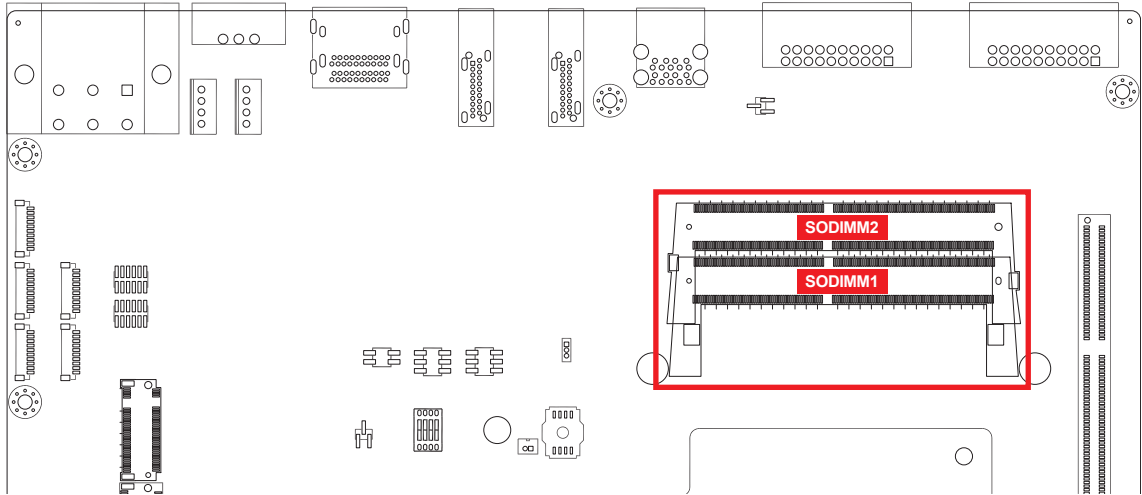

Slot	Description
SODIMM1	DDR4 Channel A
SODIMM2	DDR4 Channel B

### 2.4.4 BIOS Socket (CN1)

If the BIOS need to be changed, please contact the Vecow RMA service team.

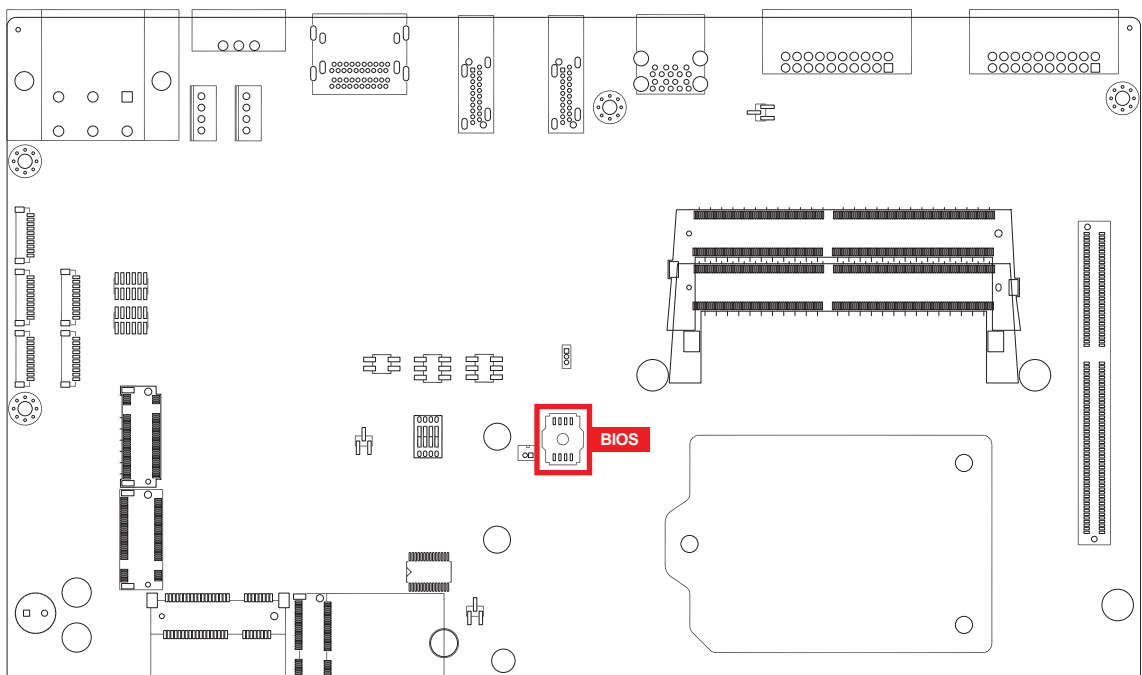

## 2.4.5 SATA Connector (SATA1/SATA2)

### Standard 7 PIN SATA Connector

There are 2 onboard high performance Serial ATA III. It supports higher storage capacity with less cabling effort and smaller required space.

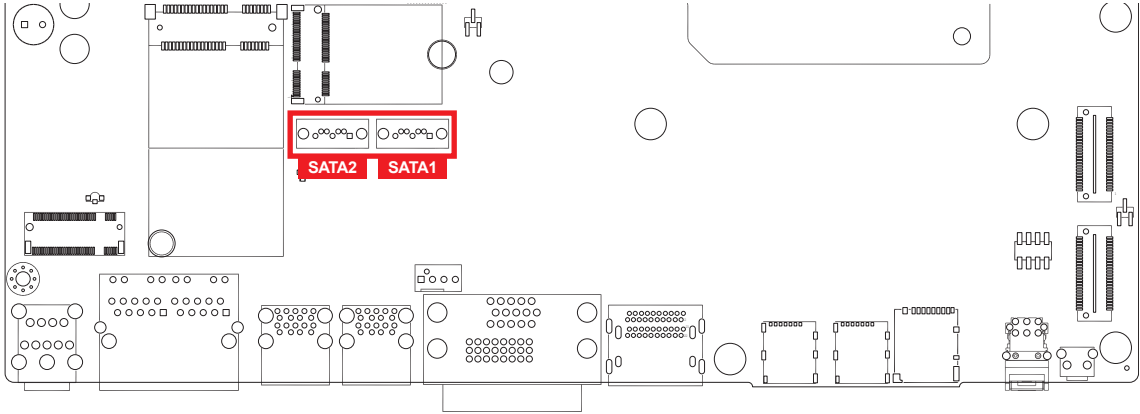

Pin No.	Description	Pin No.	Description
1	Ground	5	RX DN
2	TX DP	6	RX DP
3	TX DN	7	Ground
4	Ground		

## 2.4.6 SATA Power Header (HDDpPWR1/HDD\_PWR2)

### Standard, All Form Factor 1x4p Power Header

There are 2 HDD power header on board and each power header supports Four 2.5" SATA HDD.

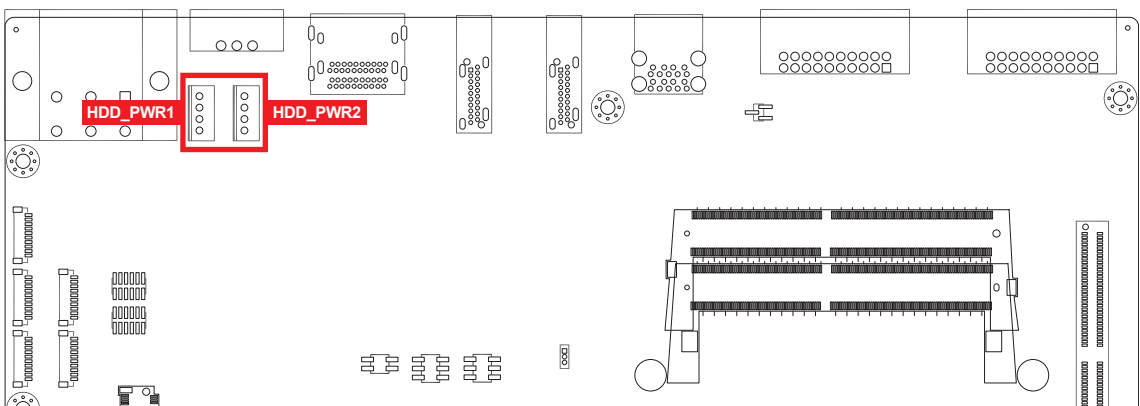

Pin No.	Description	Pin No.	Description
1	+V12 (Max. 1.5A)	2	Ground
3	Ground	4	+V5 (Max. 1.5A)

## 2.4.7 DEBUG Connector (DEBUG1)

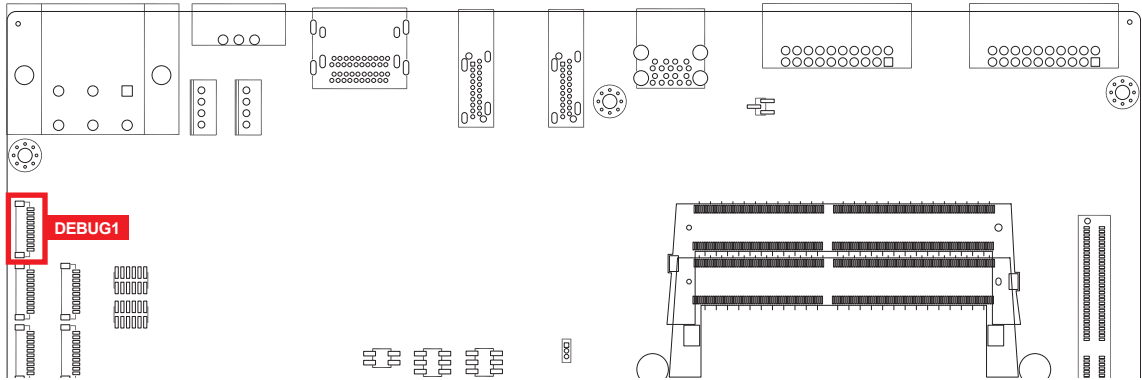

This pin header is through by LPC interface and pins define are listed in the following table.

Pin No.	Pin Name	Pin No.	Pin Name
1	3.3V	6	AD3
2	SERIRQ	7	FRAME#
3	AD0	8	24M CLCOK
4	AD1	9	RESET
5	AD2	10	GND

## 2.4.8 SUMIT Connector (SUMITA1/SUMITB1)

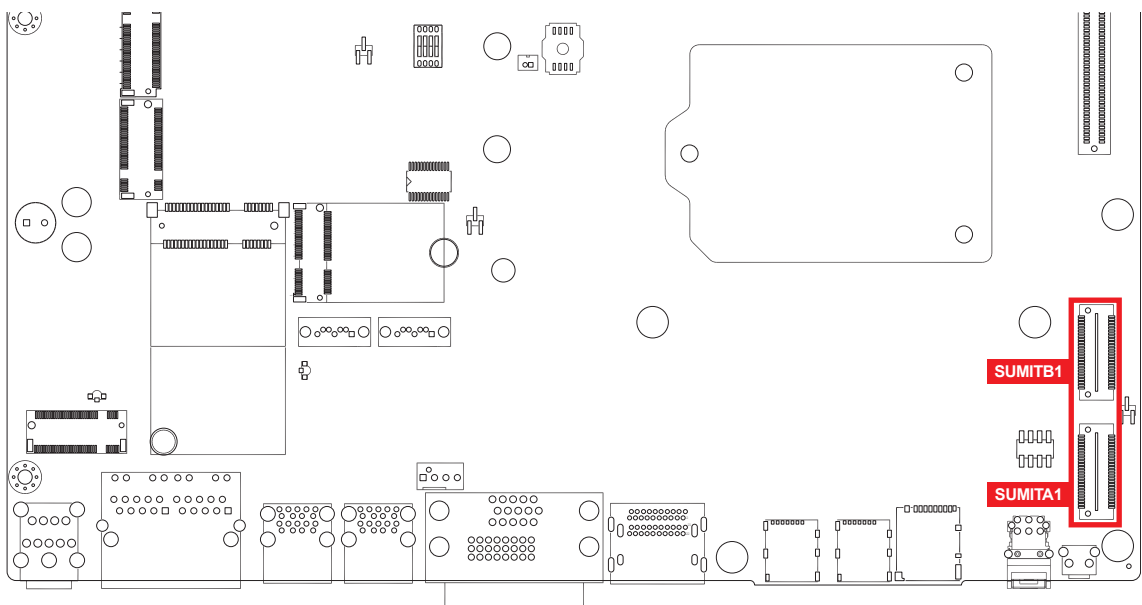



SUMIT A Pin Out :

Pin No.	Function	Pin No.	Function
1	+5V_AUX	2	+12V
3	+3.3V	4	SMB_DATA
5	+3.3V	6	XMB_CLK
7	Reserved	8	Reserved
9	Reserved	10	SPI_MISO
11	USB_OC#	12	SPI_MOSI
13	Reserved	14	SPI_CLK
15	+5V	16	SPI_CS10
17	USB_3+	18	SPI_CS1#
19	USB_3-	20	Reserved
21	+5V	22	LPC_DRQ1#
23	USB_2+	24	LPC_AD0
25	USB_2-	26	LPC_AD1
27	+5V	28	LPC_AD2
29	USB_1+	30	LPC_AD3
31	USB_1-	32	LPC_FRAME#
33	+5V	34	SERIRQ#
35	USB_0+	36	Reserved
37	USB_0-	38	CLK_33MHz
39	GND	40	GND
41	A_PET_P0	42	A_PER_P0
43	A_PET_N0	44	A_PER_N0
45	GND	46	APRSNT#/A_PE_CLKREQ#
47	PERST#	48	A_CLKP
49	WAKE#	50	A_CLKN
51	+5V	52	GND

SUMIT B Pin Out :

Pin No.	Function	Pin No.	Function
1	GND	2	GND
3	B_PET_P0	4	B_PER_P0
5	B_PET_N0	6	B_PER_N0
7	GND	8	GND
9	C_CLKP	10	B_CLKP
11	C_CLKN	12	B_CLKN
13	CPRSNT#/C_PE_CLKREQ#	14	GND
15	C_PET_P0	16	C_PER_P0
17	C_PET_N0	18	C_PER_N0
19	GND	20	GND
21	C_PET_P1	22	C_PER_P1
23	C_PET_N1	24	C_PER_N1
25	GND	26	GND
27	C_PET_P2	28	C_PER_P2
29	C_PET_N2	30	C_PER_N2
31	GND	32	GND
33	C_PET_P3	34	C_PER_P3
35	C_PET_N3	36	C_PER_N3
37	GND	38	GND
39	PERST#	40	WAKE#
41	Reserved	42	Reserved
43	+5V	44	Reserved
45	+5V	46	+3.3V
47	+5V	48	+3.3V
49	+5V	50	+3.3V
51	+5V	52	+5V_AUX

## 2.4.9 Mini PCIe

Standard full length Mini PCIe slot :

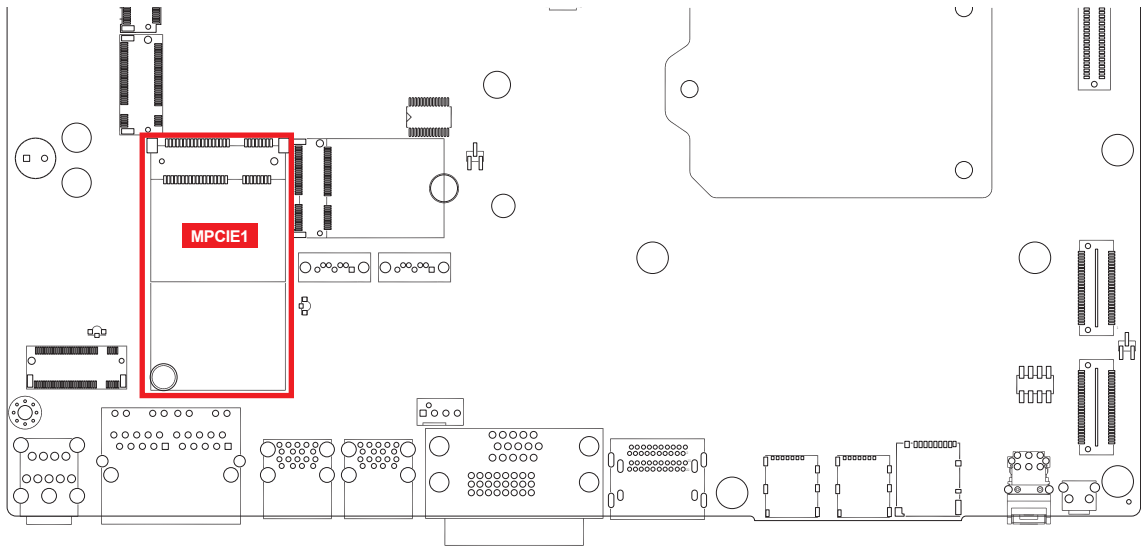

Pin Out :

Pin No.	Description	Pin No.	Description
51	Reserved	52	+3.3Vaux
49	Reserved	50	GND
47	Reserved	48	+1.5V
45	Reserved	46	Reserved
43	GND	44	Reserved
41	+3.3Vaux	42	Reserved
39	+3.3Vaux	40	GND
37	GND	38	USB_D+
35	GND	36	USB_D-
33	PETp0	34	GND
31	PETn0	32	SMB_DATA
29	GND	30	SMB_CLK
27	GND	28	+1.5V
25	PERn0	26	GND
23	PERp0	24	+3.3Vaux
21	GND	22	PERST#
19	Reserved	20	reserved
17	Reserved	18	GND
Mechanical Key			

Pin No.	Description	Pin No.	Description
15	GND	16	UIM_VPP
13	REFCLK+	14	UIM_RESET
11	REFCLK-	12	UIM_CLK
9	GND	10	UIM_DATA
7	CLKREQ#	8	UIM_PWR
5	Reserved	6	1.5V
3	Reserved	4	GND
1	WAKE#	2	3.3Vaux

### 2.4.10 RTC Battery (BAT1)

The system's real-time clock is powered by a lithium battery. It is Equipped with Panasonic BR2032 190mAh lithium battery. It is recommended that you not replace the lithium battery on your own. If the battery needs to be changed, please contact the Vecow RMA service team.

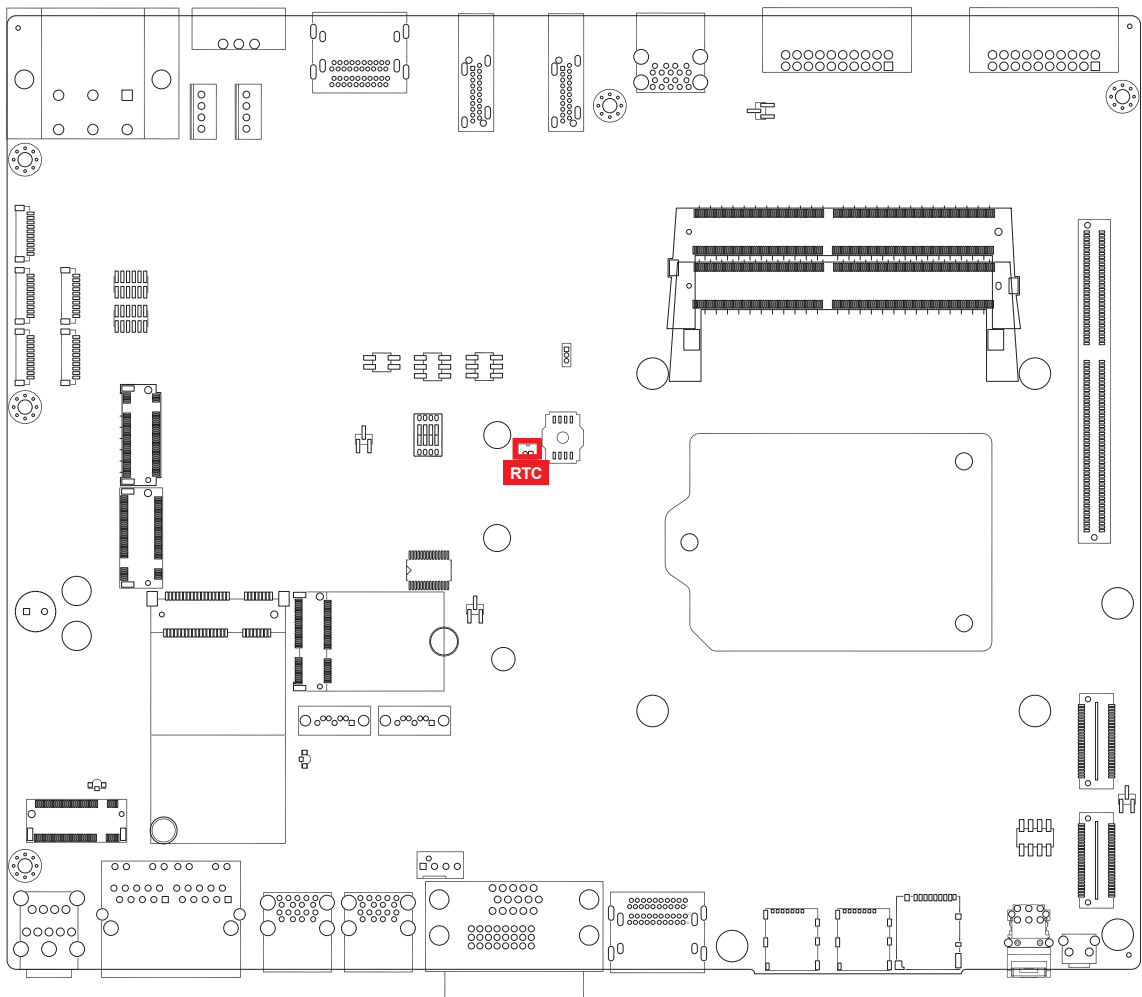

### 2.4.11 Fan Connector (CPU\_FAN1/MXM\_FAN1)

Fan power connector supports for additional thermal requirements. The pin assignments of CPU\_FAN1 and MXM\_FAN1 are listed in the following table.

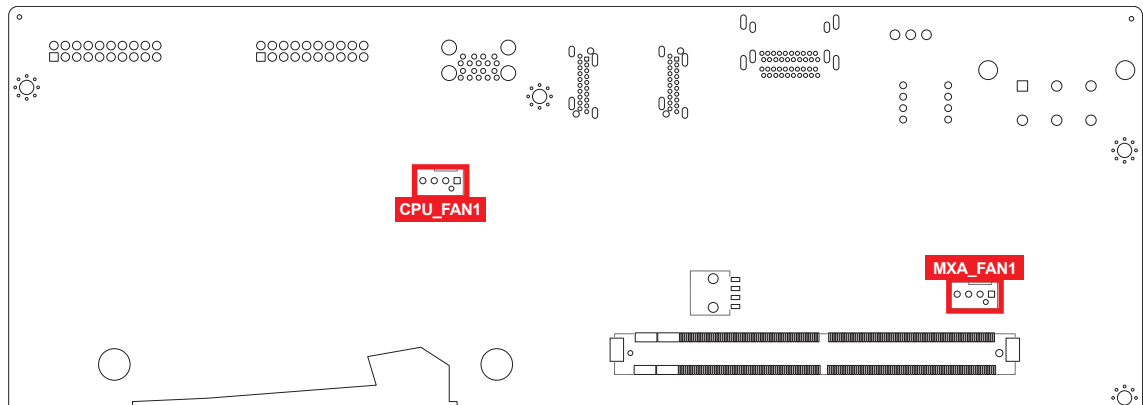

Pin No.	Description	Pin No.	Description
1	GND	2	+12V (2A max)
3	Fan speed sensor	4	Fan PWM

### 2.4.12 MXM POWER (MXMPWR1)

This connector provides +12V for MXM Graphic card only and the pin define are listed in the following table.

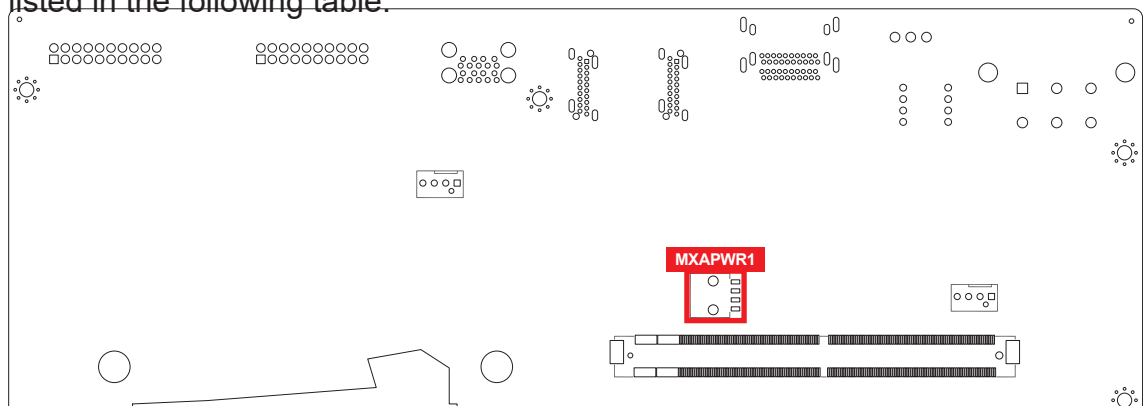

Pin No.	Description	Pin No.	Description
1	GND	2	GND
3	12V	4	12V

### 2.4.13 COM Port (COM1-COM4)

EVS-2000 provides 4 serial ports (COM1-COM4) headers for internal COM port cable and the pin define are listed in the following table.

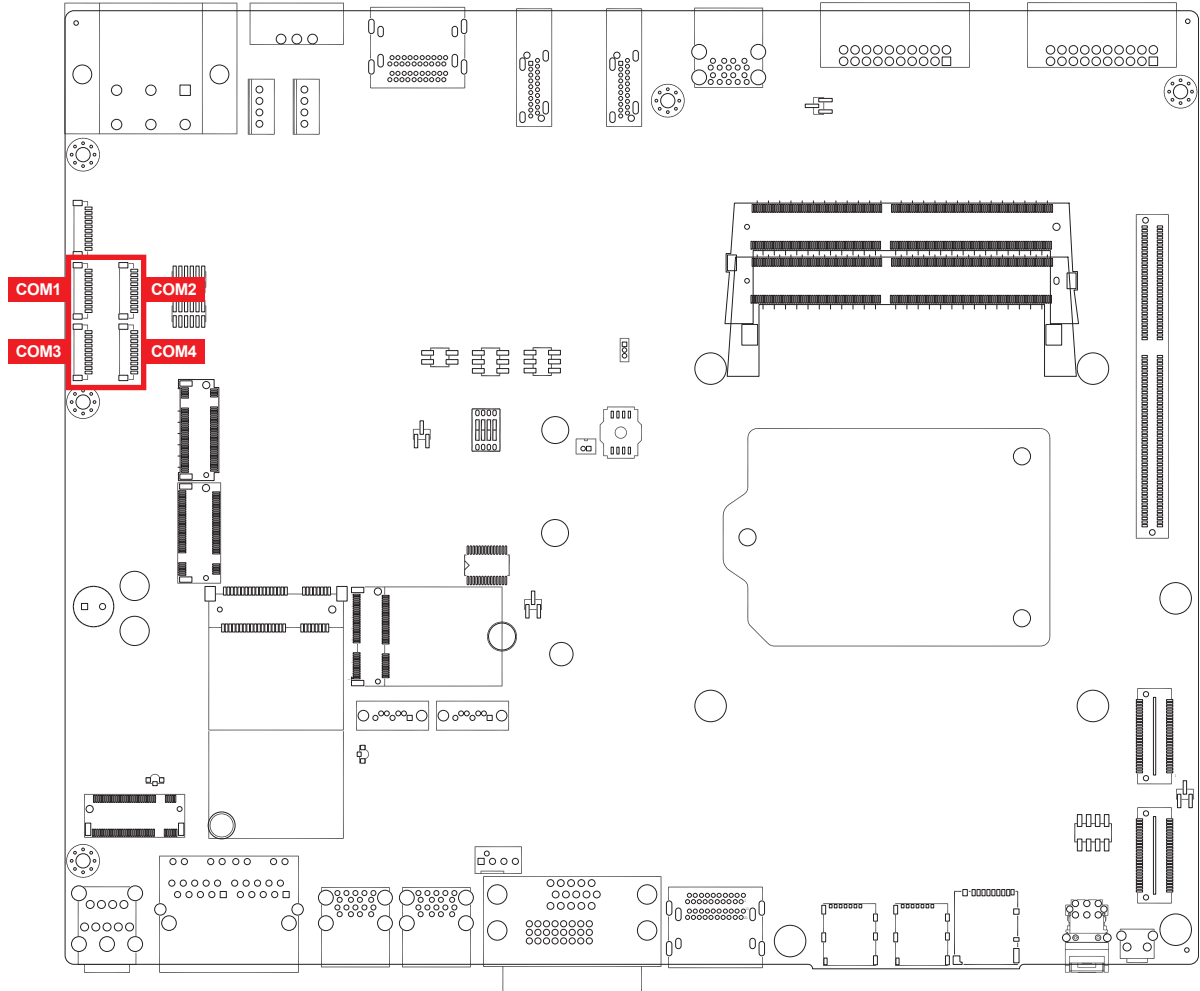

#### COM3

Pin No.	Description	Pin No.	Description
1	NC	6	TXD
2	Ground	7	RTS
3	RI	8	RXD
4	DTR	9	DSR
5	CTS	10	DCD

## 2.4.14 M.2 KEY-E (M2E\_CN1)

USB 2.0/PCIe x1

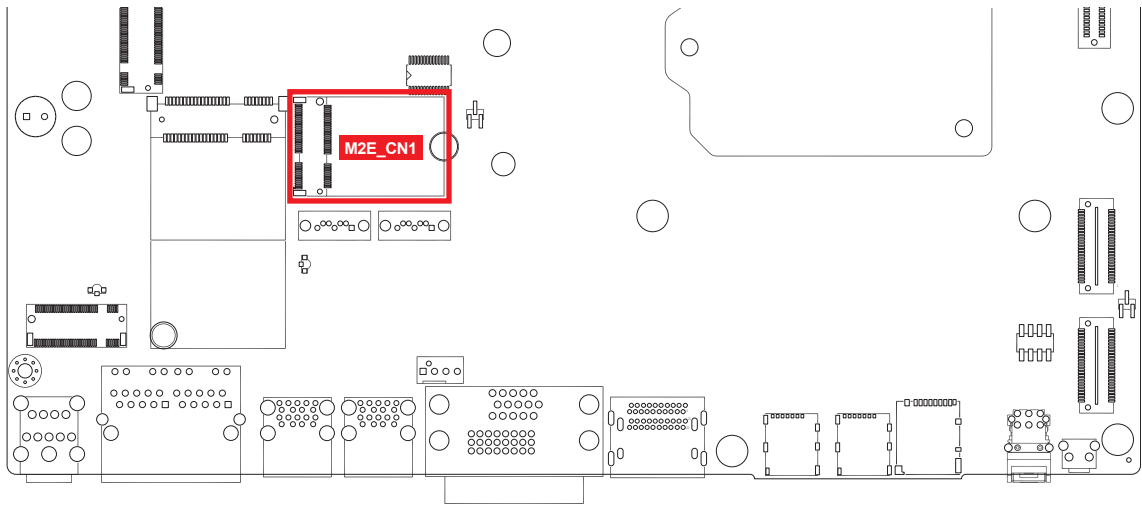

M.2 KEY E : USB 2.0/PCIe x1 M.2 key E connector is suitable for applications that use wireless connectivity including Wi-Fi, Bluetooth, NFC or GNSS. Module card types include 2230.

Pin Out :

Pin No.	Description	Pin No.	Description
75	GND	74	+V3.3_AUX
73	NC	72	+V3.3_AUX
71	NC	70	NC
69	GND	68	PCIE_CLK_REQ#
67	NC	66	NC
65	NC	64	M2E_REFCLK
63	GND	62	SMB_ALERT#
61	NC	60	SMB_CLK
59	NC	58	SMB_DATA
57	GND	56	M2E_WLAN_DISABLE
55	PCIE_WAKE#	54	M2E_BT_DISABLE
53	PCIE_CLK_REQ0#	52	PLTRST#
51	GND	50	SUS_CLK
49	PCIE_100M_CLK__N	48	NC
47	PCIE_100M_CLK__P	46	NC
45	GND	44	CNVI_BLANKING
43	PCIE_RX_N	42	CL_CLK
41	PCIE_RX_P	40	CL_DATA
39	GND	38	CL_RST_N

Pin No.	Description	Pin No.	Description
37	PCIE_TX_N	36	NC
35	PCIE_TX_P	34	NC
33	GND	32	NC
Mechanical Key			
23	NC		
21	NC	22	NC
19	GND	20	NC
17	NC	18	GND
15	NC	16	LED2#
13	GND	14	NC
11	NC	12	NC
9	NC	10	NC
7	GND	8	NC
5	USB-	6	LED1#
3	USB+	4	+V3.3_AUX
1	GND	2	+V3.3_AUX

### 2.4.15 M.2 KEY-M (M2M\_CN1)

M.2 KEY M : PCIe x4/SATA Support M.2 key M connector is suitable for applications that use Host I/Fs supported by either PCIe or SATA, or Solid State Storage Devices (SSD). Module card types include 2280.

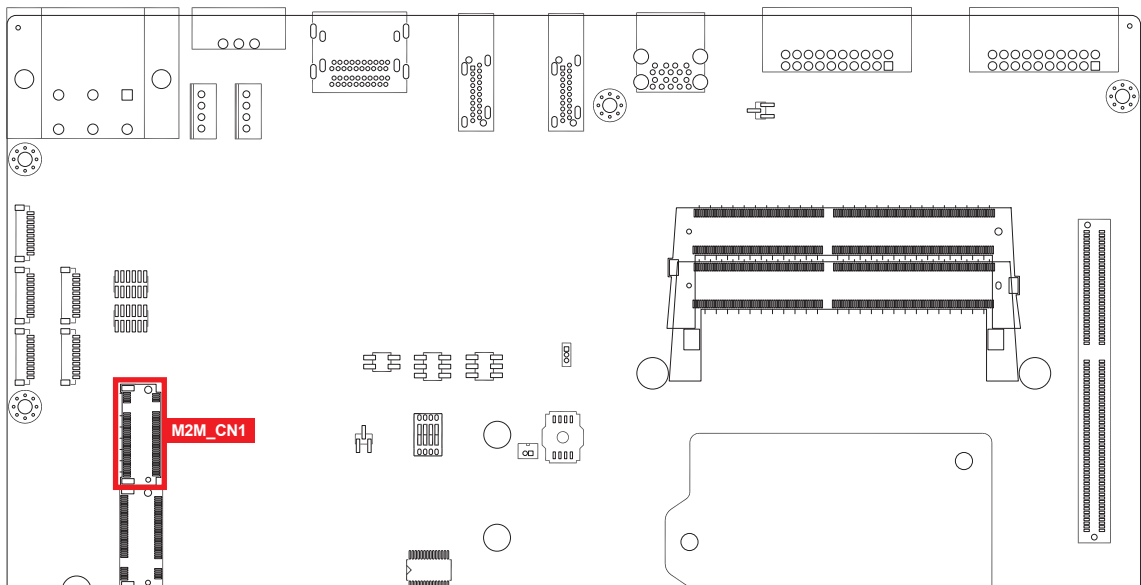



## 2.4.16 M.2 KEY-B (M2B\_CN1/M2B\_CN2)

M.2 KEY-B USB 3.0/USB 2.0 Support (default), PCIe x2 (BIOS option)

M2B\_CN1 Module card types include 3042/3052, and M2B\_CN2 Module card types include 2280.

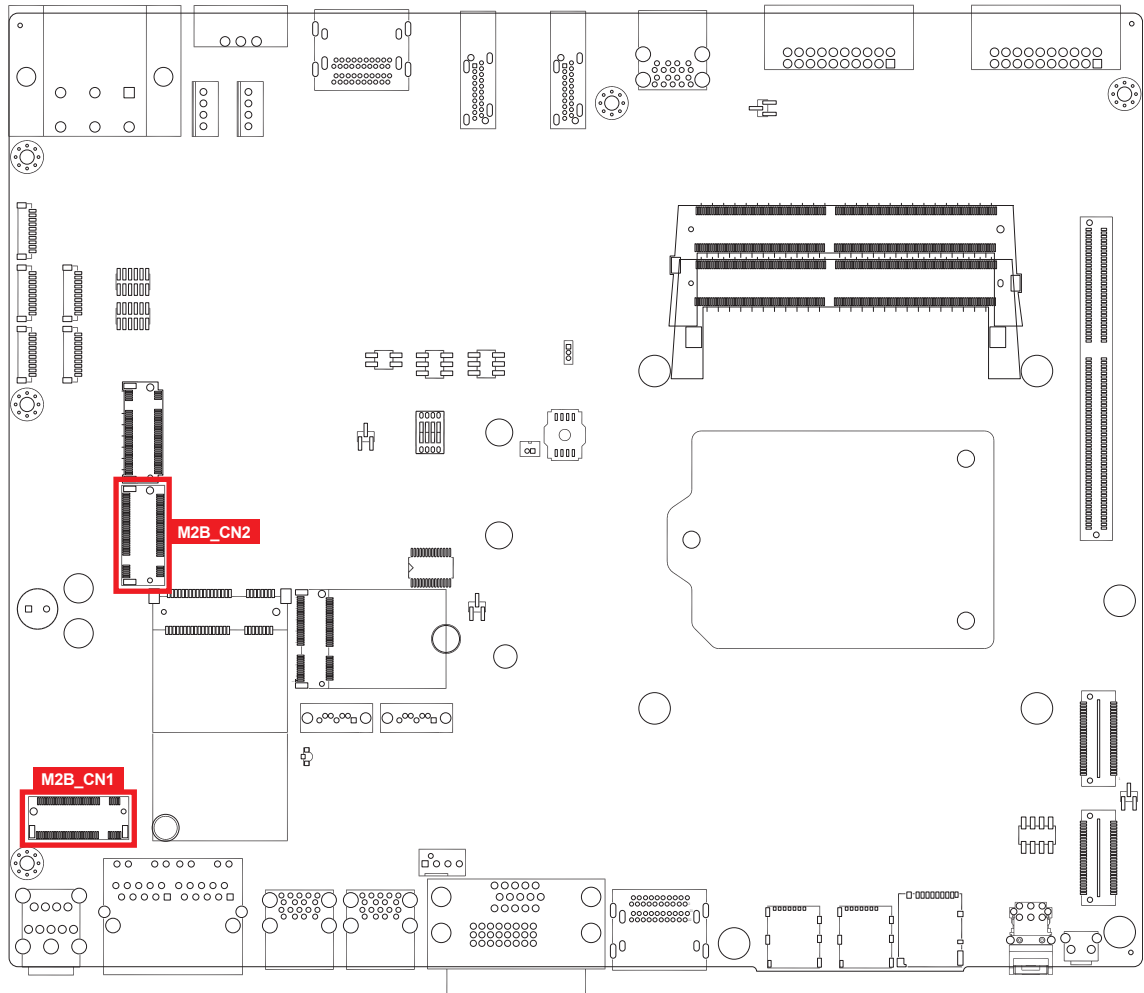

## 2.5 Main Board Jumper Settings

### 2.5.1 Board Top View of EVS-2000 Main Board with Jumper and DIP Switch

The figure below is the top view of EVS-2000 main board which is the main board. It shows the location of the jumpers and the switches.

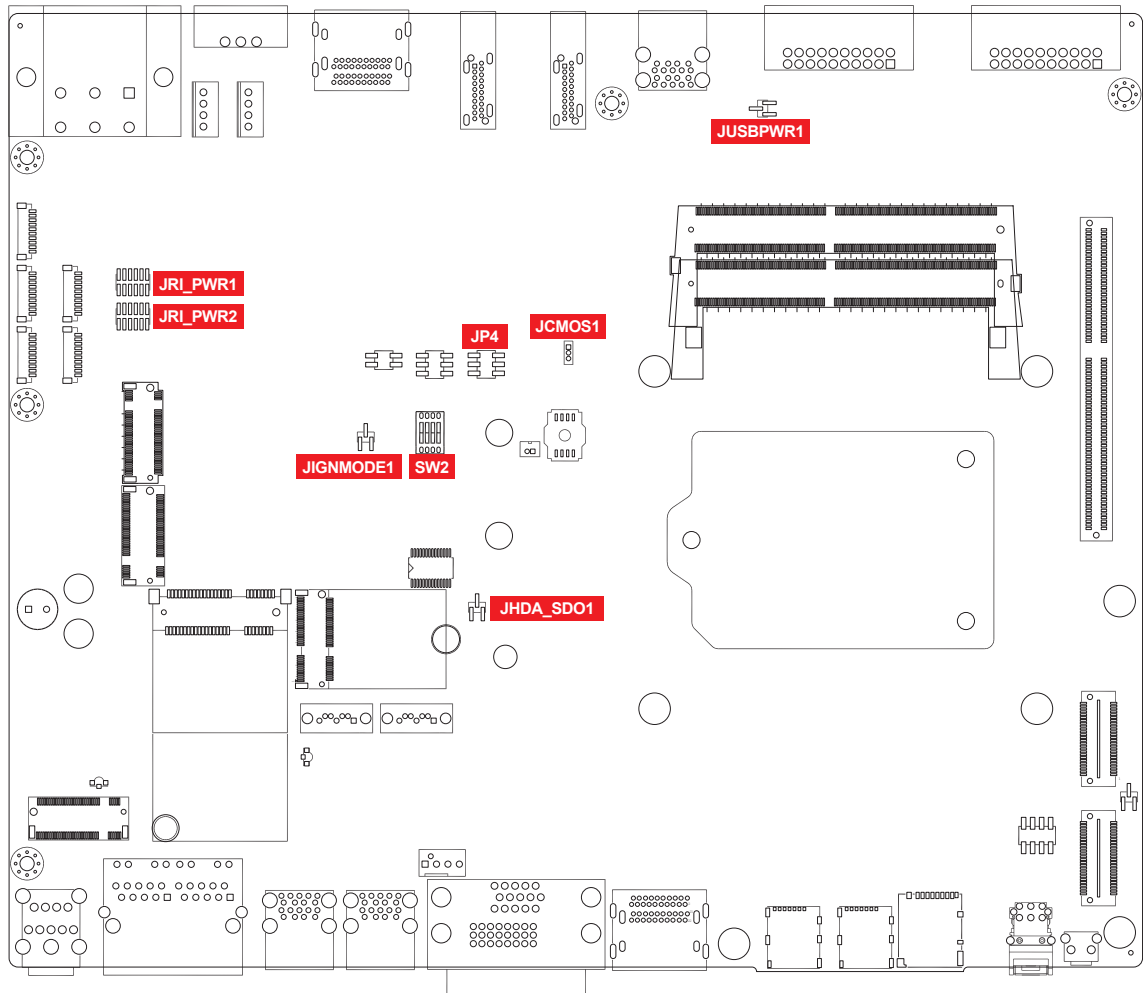

You may configure your card to match the needs of your application by setting jumpers. A jumper is a metal bridge used to close an electric circuit. It consists of two metal pins and a small metal clip (often protected by a plastic cover) that slides over the pins to connect them. To "close" a jumper, you connect the pins with the clip. To "open" a jumper, you remove the clip. Sometimes a jumper will have three pins, labeled 1, 2 and 3. In this case you would connect either pins 1 and 2, or 2 and 3.

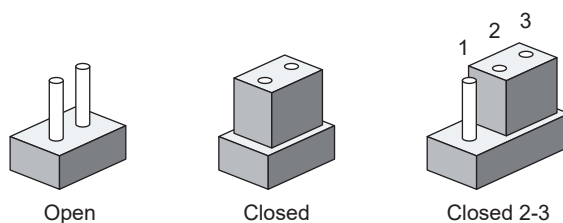

You may configure your card to match the needs of your application by DIP switch. As below show the DIP switch on and off.

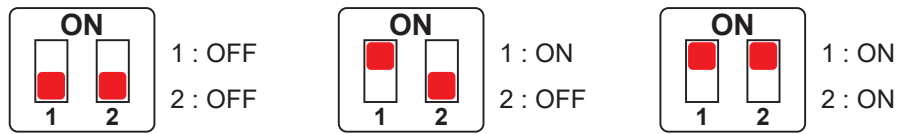

## 2.5.2 USB Power Jumper (JUSBPWR1)

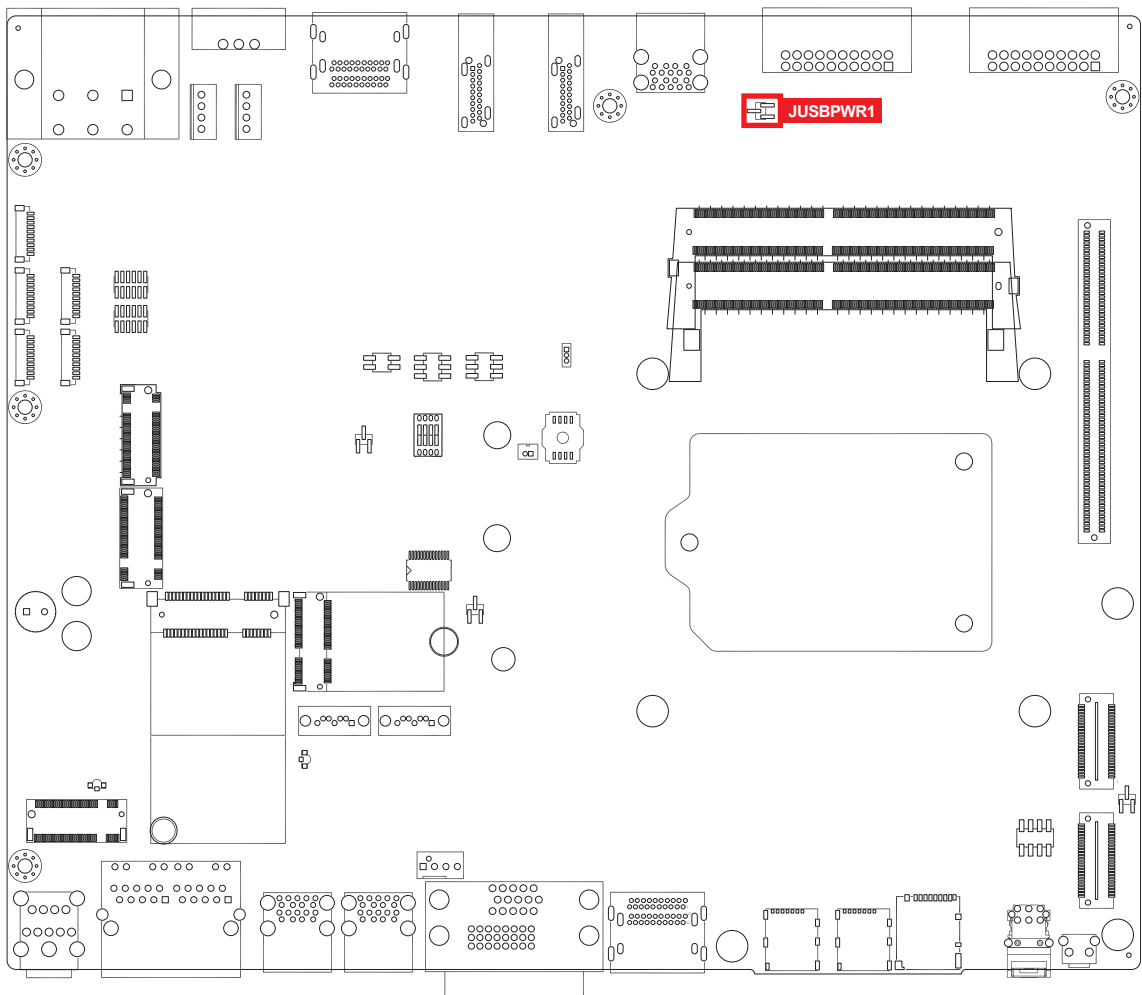

Jumper	Setting	Function
JUSBPWR1	1 : 2	Supported Wake Up (Default)
	2 : 3	Non Wake Up support

### 2.5.3 COM Port RI Pin Select (JRI\_PWR1/JRIPWR2)

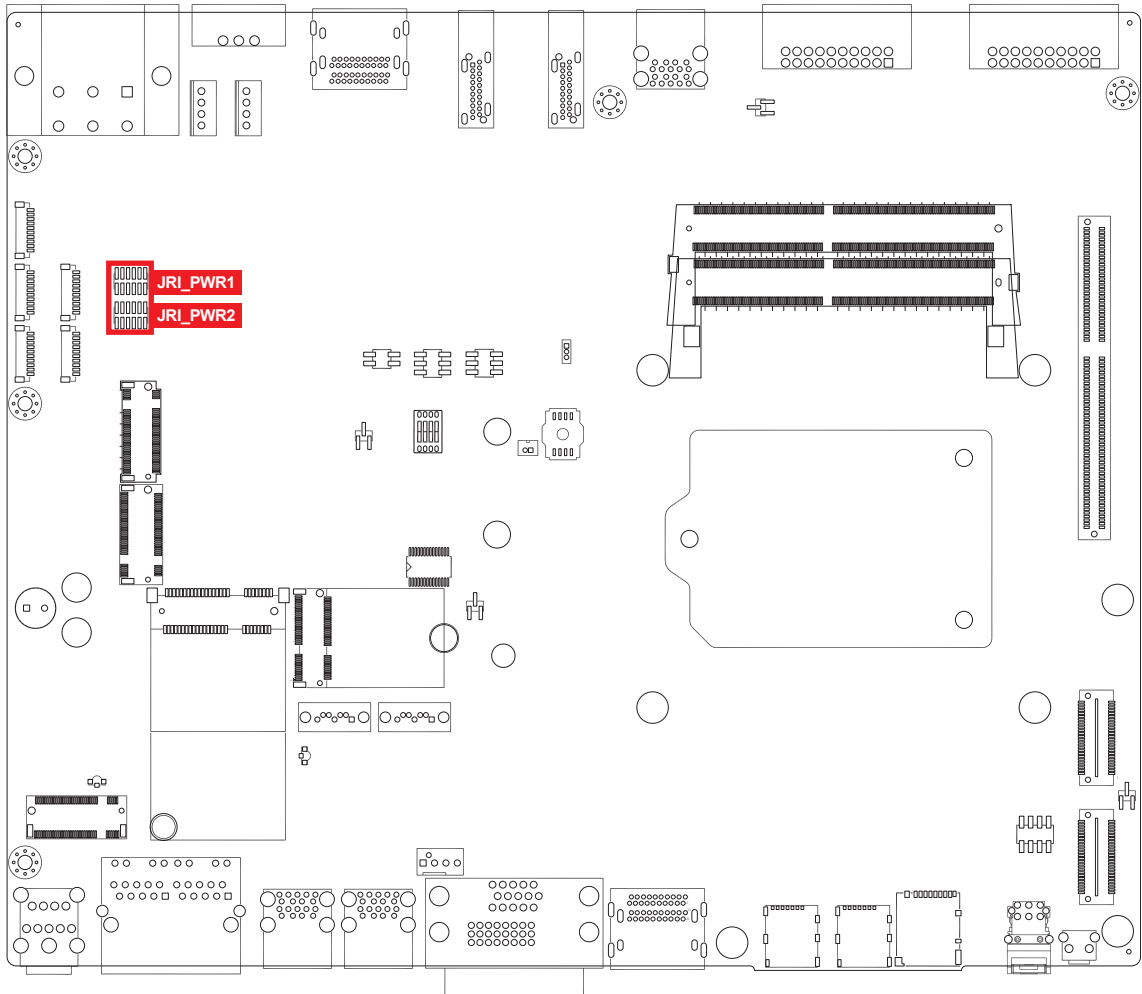

Pin Header	Pin No.	Description
JRI_PWR1	1 - 2	+12V (1A max.)
	3 - 4	
	5 - 6	COM1 RI (Default)
	7 - 8	+12V (1A max.)
	9 - 10	
	11 - 12	COM2 RI (Default)

Pin Header	Pin No.	Description
JRI_PWR2	1 - 2	+12V (1A max.)
	3 - 4	
	5 - 6	COM3 RI (Default)
	7 - 8	+12V (1A max.)
	9 - 10	
	11 - 12	COM4 RI (Default)

## 2.5.4 MXM VGA Disable (JP4)

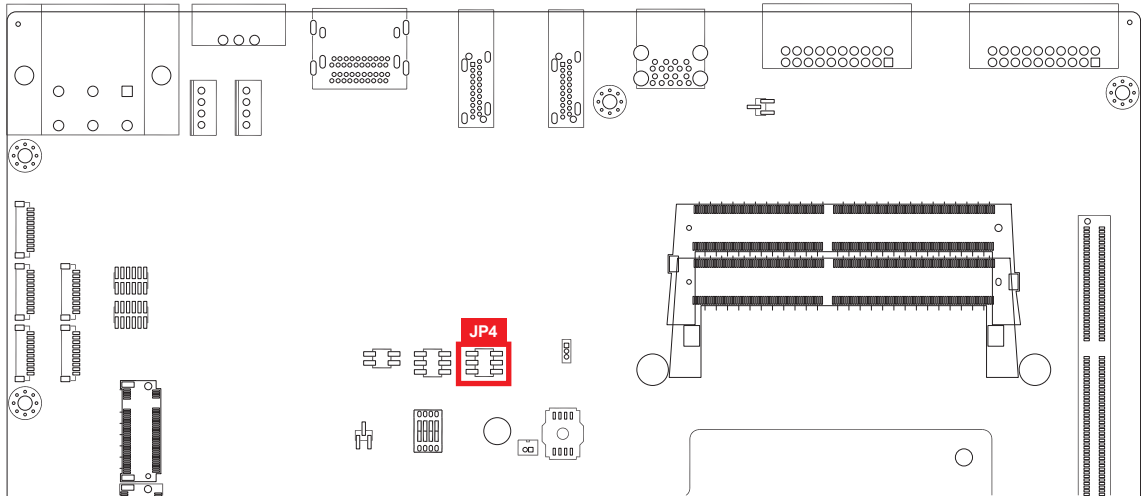

Jumper	Setting	Function
JP4	1 : 3	MXM VGA Enable
	3 : 5	MXM VGA Disable

## 2.5.5 Clear CMOS

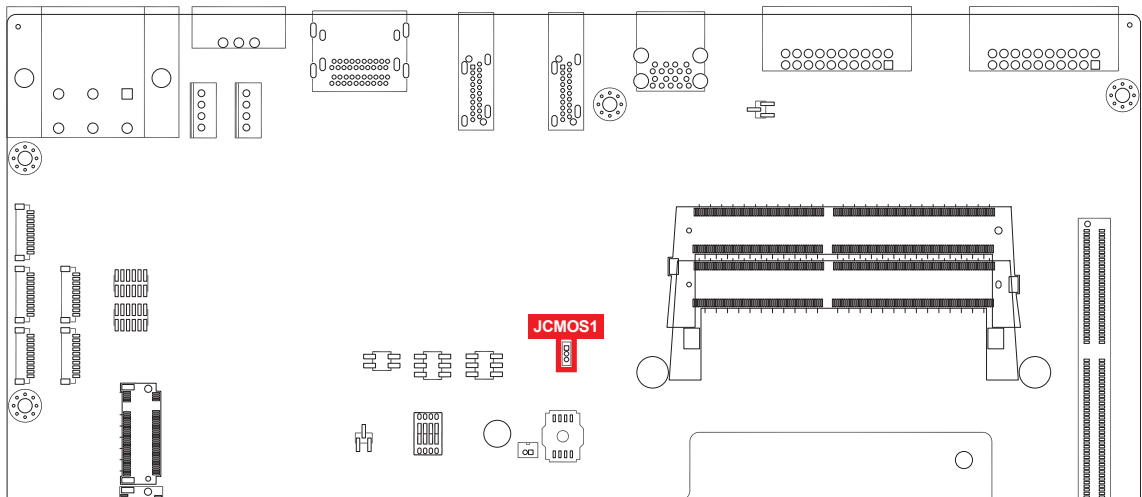

Jumper	Setting	Function
JCMOS1	1 : 2	*Normal (Default)
	2 : 3	Clear CMOS

## 2.5.6 JHDA\_SDO1

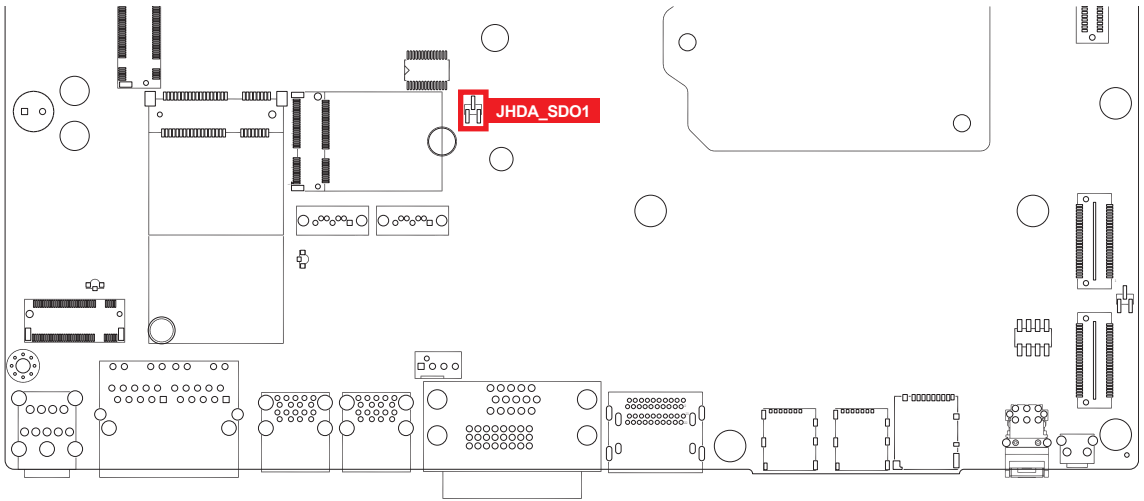

Jumper	Setting	Function
HDA_SDO1	1 : 2	*Enable security measures defined in the Flash Descriptor. (Default)
	2 : 3	Disable Flash Descriptor Security (override)

## 2.5.7 Ignition Mode (JIGNMODE1)

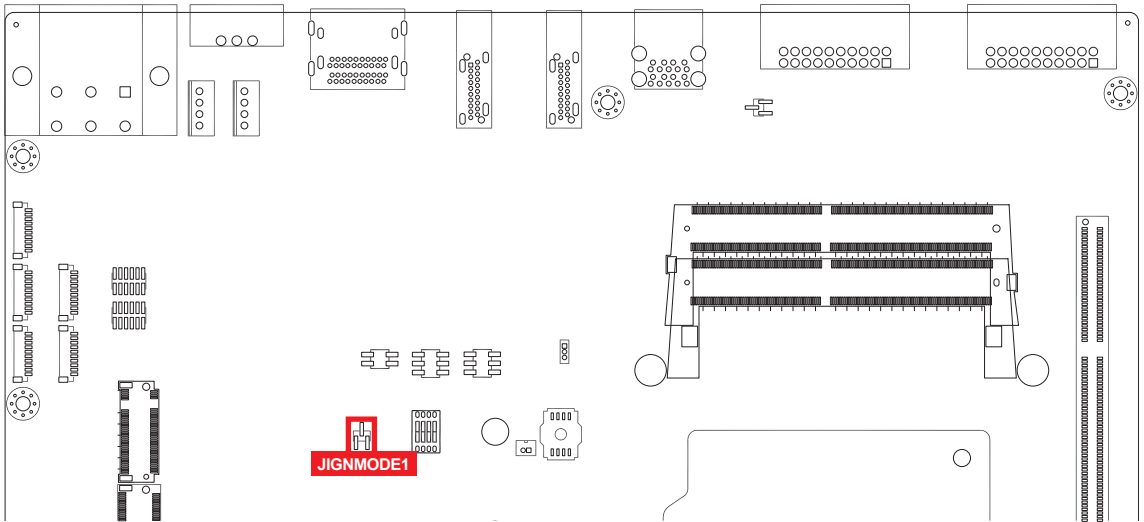

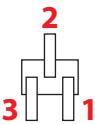
	Jumper	Setting	Function
	JIGNMODE1		1 : 2
		2 : 3	S/W mode (default)





## 2.6 Ignition Control

EVS-2000 series provides ignition power control feature for in-vehicle applications. The built-in MCU monitors the ignition signal and turns on/off the system according to pre-defined on/off delay period.

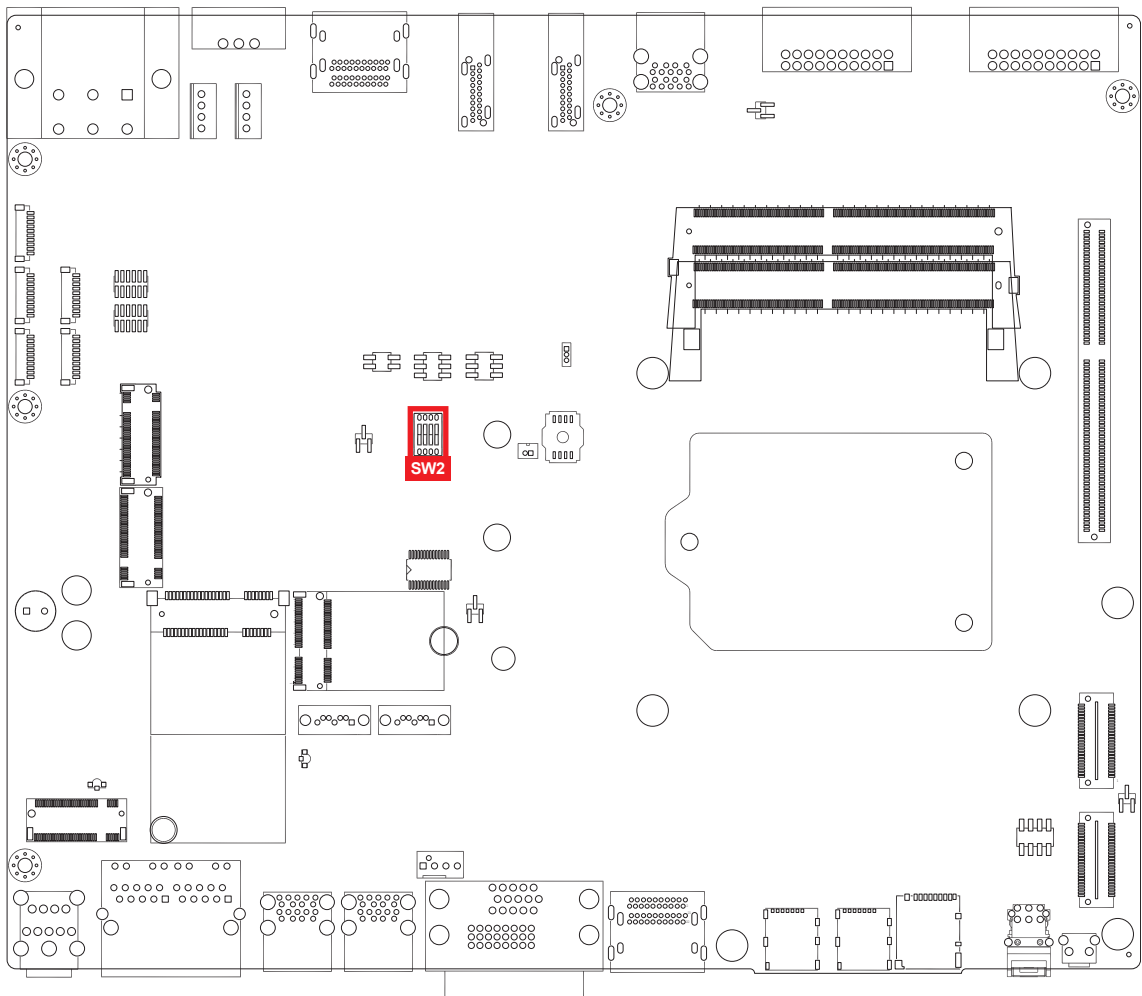
### 2.6.1 Adjust Ignition Control Modes

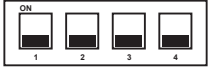
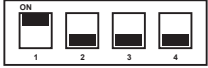
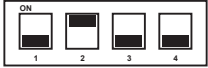
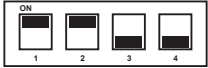
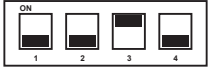
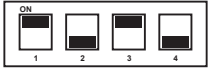
EVS-2000 series provides 16 modes of different power on/off delay periods adjustable via SW2 switch. The default rotary switch is set to 0 in ATX/AT power mode. For the setting of software IGN, please refer to 4.4.3 GPIO Manager Control.

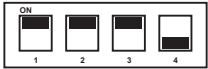
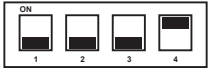
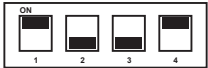
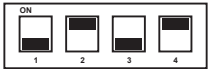
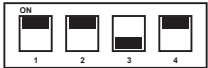

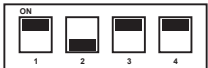
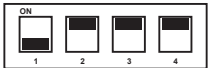
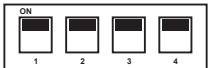
Item	Power On Delay	Power Off Delay	Switch Position
0	ATX/AT mode (Default)		
1	No delay	No delay	
2	No delay	5 seconds	
3	No delay	10 seconds	
4	No delay	20 seconds	
5	5 seconds	30 seconds	
6	5 seconds	60 seconds	
7	5 seconds	90 seconds	
8	5 seconds	30 minutes	
9	5 seconds	1 hour	
A	10 seconds	2 hours	
B	10 seconds	4 hours	
C	10 seconds	6 hours	
D	10 seconds	8 hours	
E	10 seconds	12 hours	
F	10 seconds	24 hours	



## 2.6.2 Ignition Control Wiring

To activate ignition control, you need to provide IGN signal via the 3-pin pluggable terminal block located in the back panel. Please find below the general wiring configuration.

Pin No.	Definition
1	Ignition (IGN)
2	SW+
3	SW-

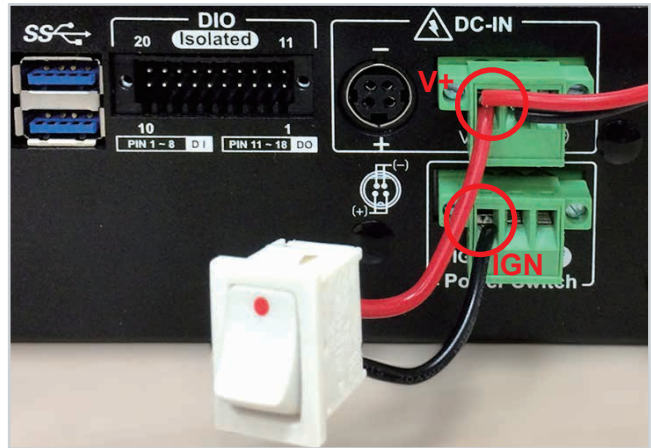

For testing purpose, you can refer to the picture below to simulate ignition signal input controlled by a latching switch.

Note :

1. DC power source and IGN share the same ground.
2. EVS-2000 supports 9V to 50V wide range DC power input in ATX/AT mode. In Ignition mode, the input voltage such as the wide voltage operating range of the system is 9V to 50V DC.
3. For proper ignition control, the power button setting should be "Power Down" mode.

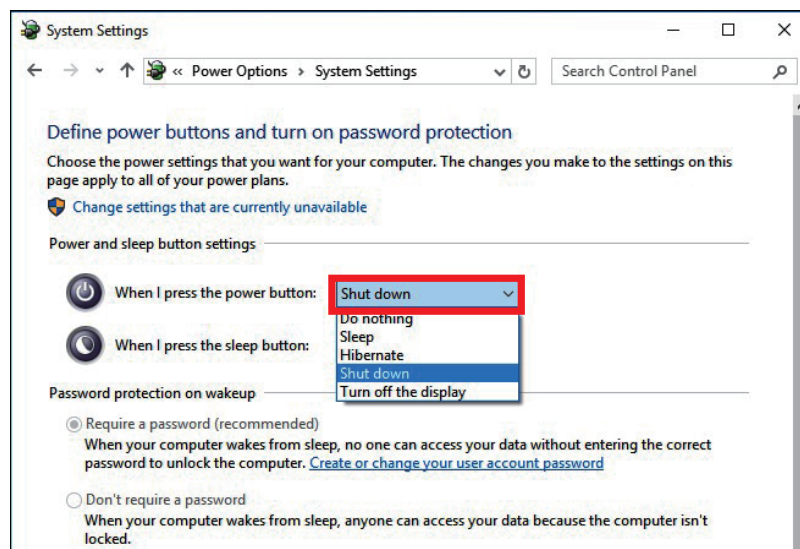

In Windows for example, you need to set "When I press the power button" to Shut down.

# 3

## SYSTEM SETUP

### 3.1 How to Open Your EVS-2000

**Step 1** Remove one F-M3x4L screw.



**Step 2** Remove one F-M3x4L (Red) and trigger and open PCI cover (Blue).



**Step 3** Remove six F-M3x4L screws.



**Step 4** Take off the bottom cover.

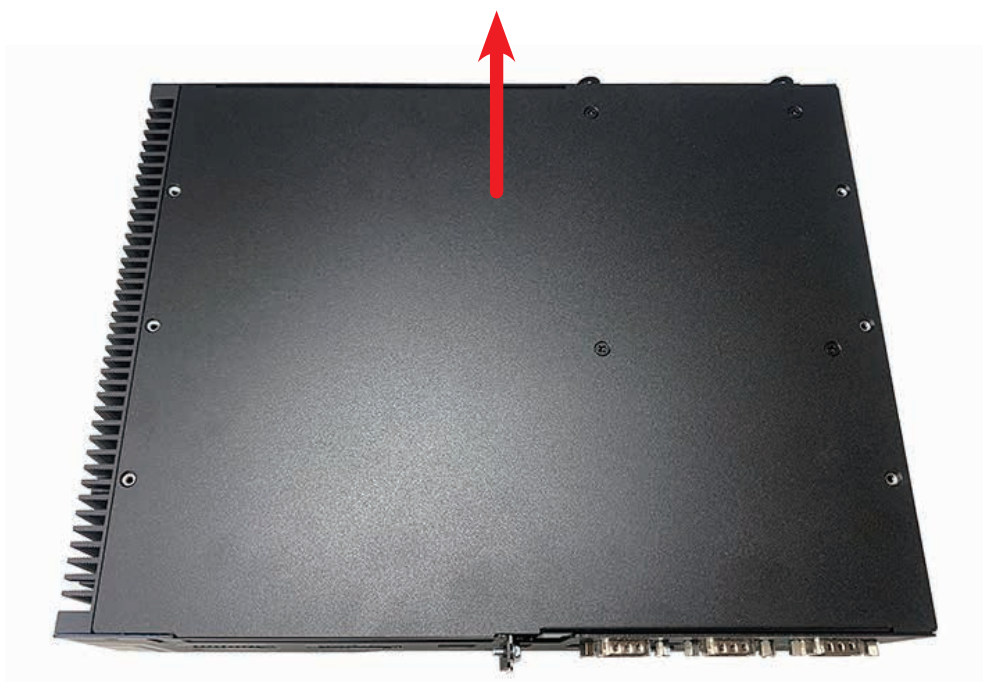

**Step 5** Finish.

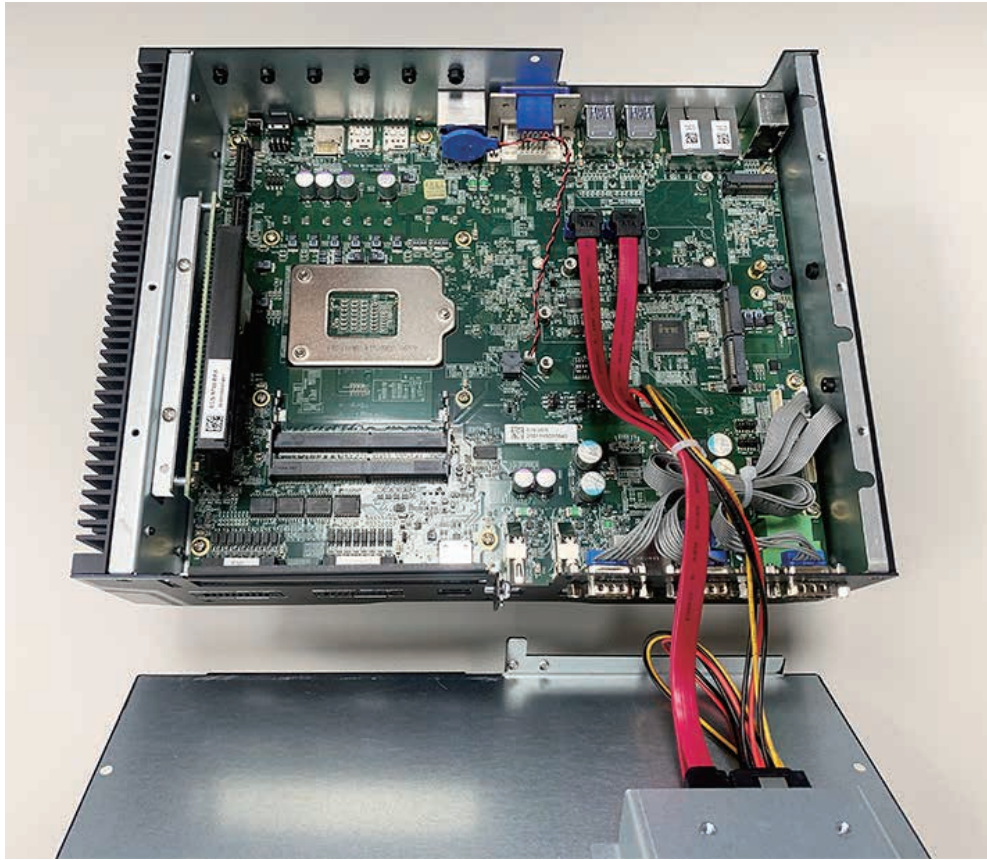

## 3.2 Installing CPU

**Step 1** Open the Heat Sink.

EVS-2000

**Step 1-1** Remove six I-M3x6L screws.



EVS-2000F

**Step 1-1** Remove four F-M3x4L screws.



**Step 1-2** Remove fan module header.

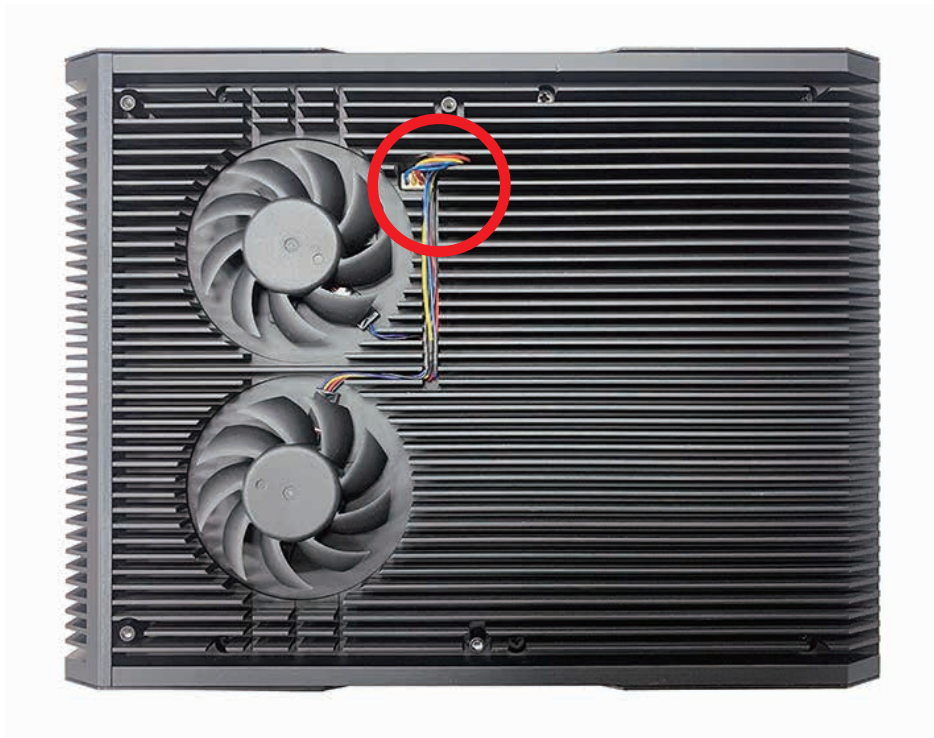

**Step 1-3** Remove six I-M3x6L screws.



**Step 2** Remove the four I-M3x3L screws.

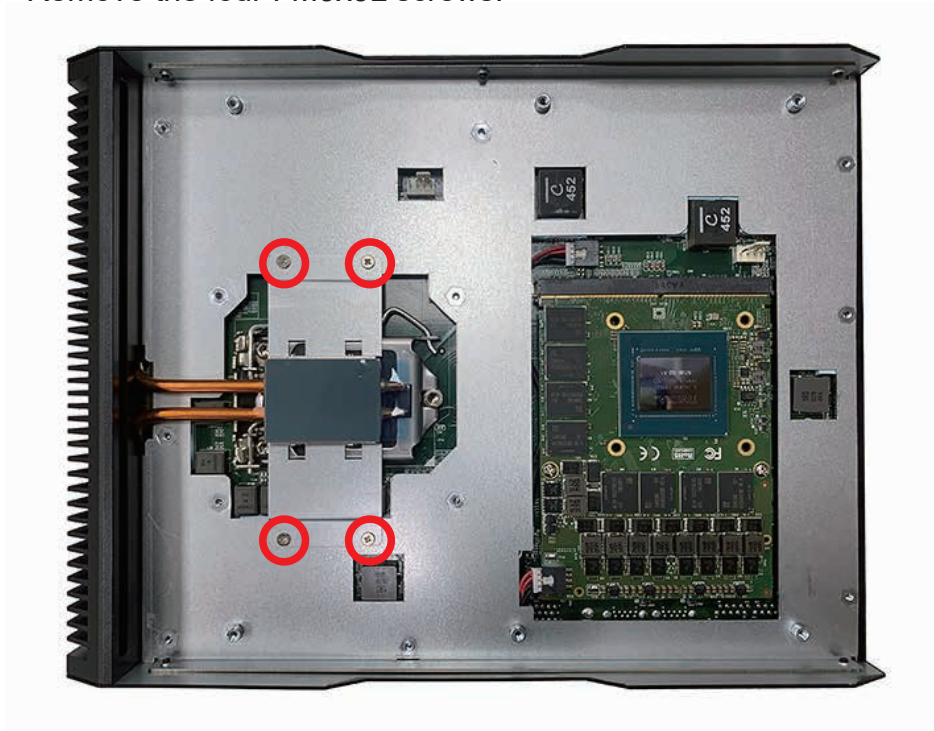

**Step 3** Remove four I-M3x6L screws.



**Step 4** Open CPU slot. (Be careful CPU pin)

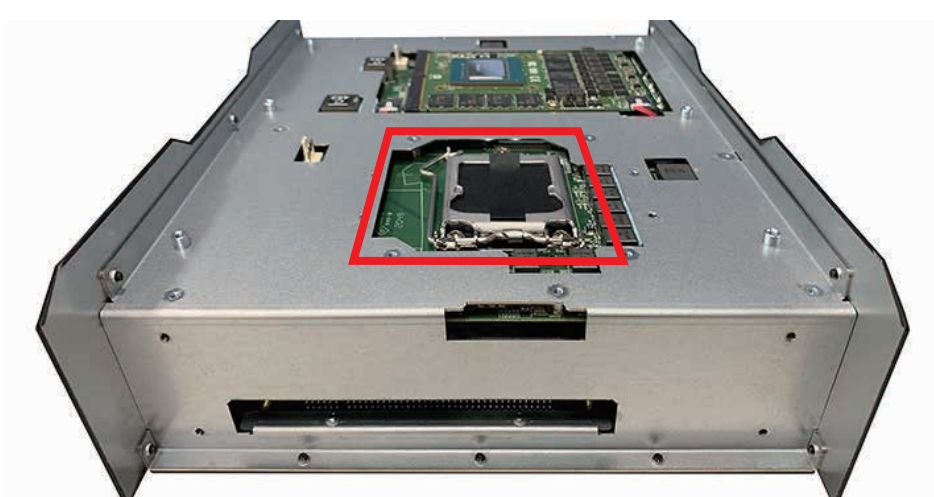

**Step 5** Installing CPU on the slot and remove the mylar.

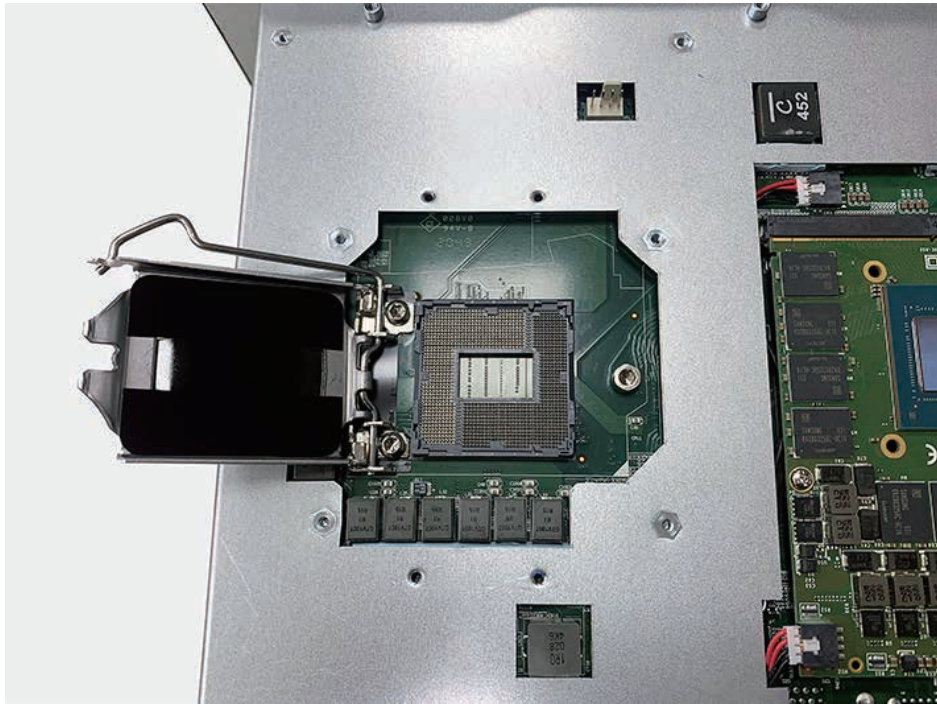

**Step 6** Cover and lock the CPU socket.





**Step 7** Apply thermal grease like "X".

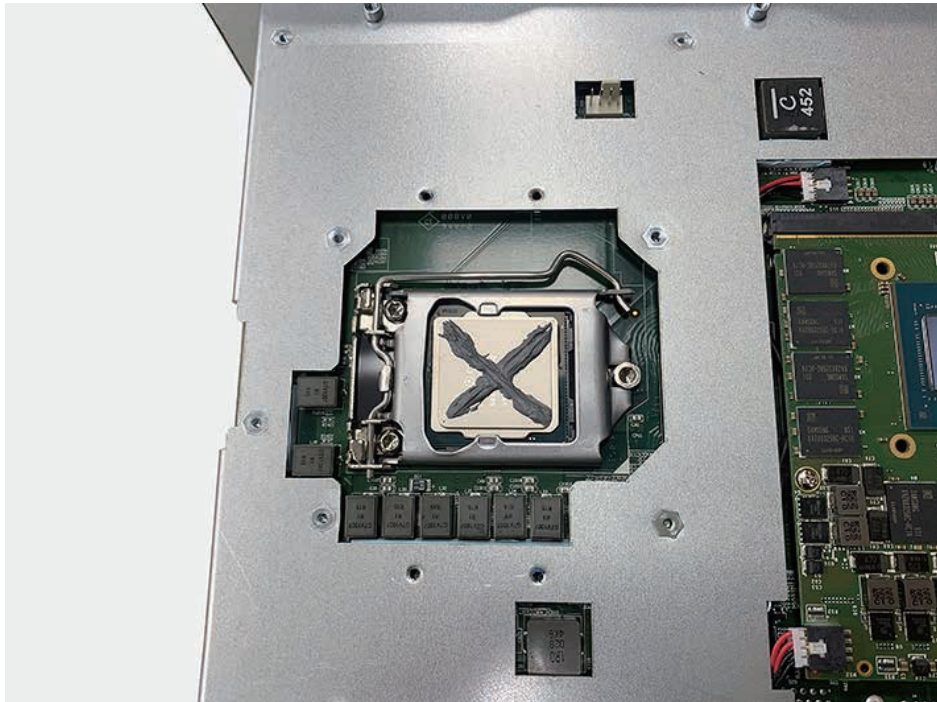

**Step 8** Cover the copper then fasten four I-M3x3L screws and remove thermal pad mylar.

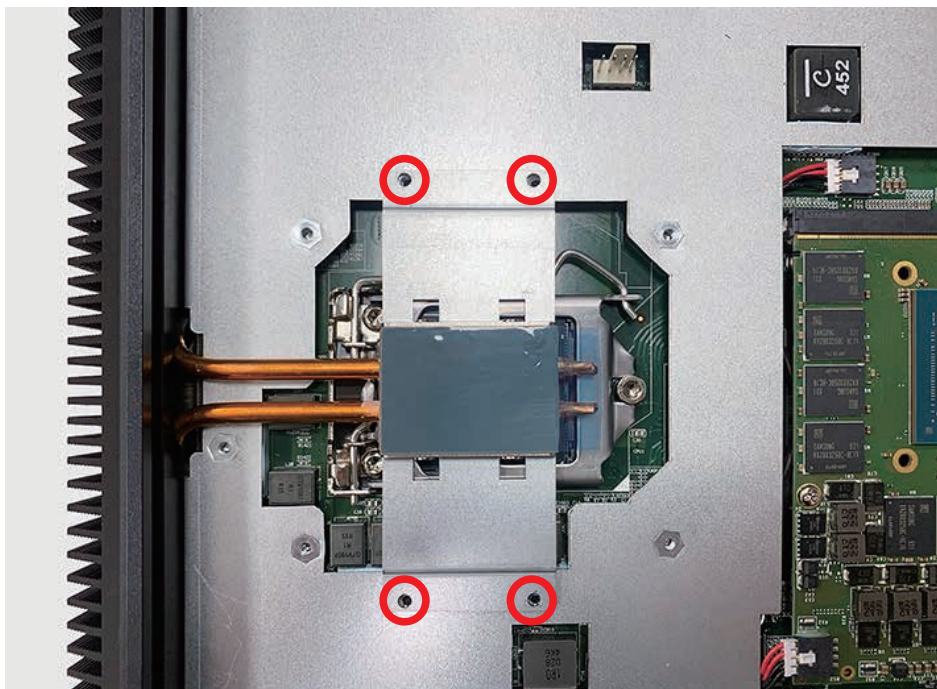

**Step 9** Fasten four I-M3x6L screws.

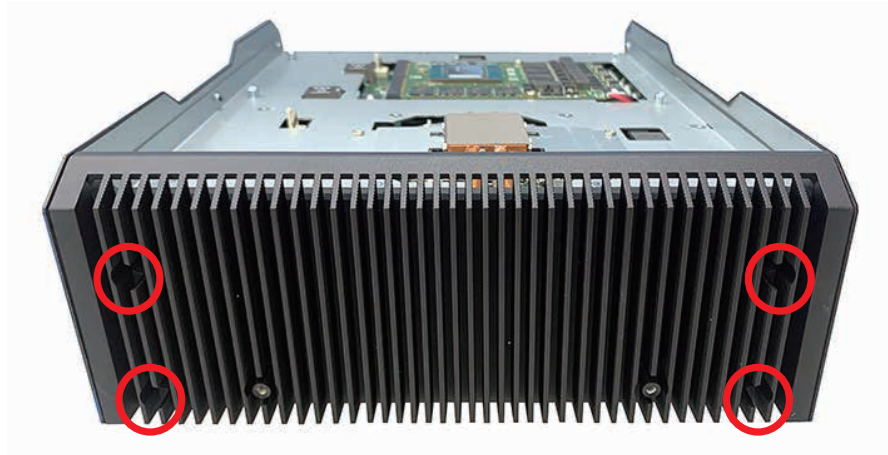

### 3.3 Installing DDR4 SO-DIMM Modules

Step 1 DDR4 RAM module into SO-DIMM slot.



Step 2 Make sure the RAM module is locked by the memory slot.

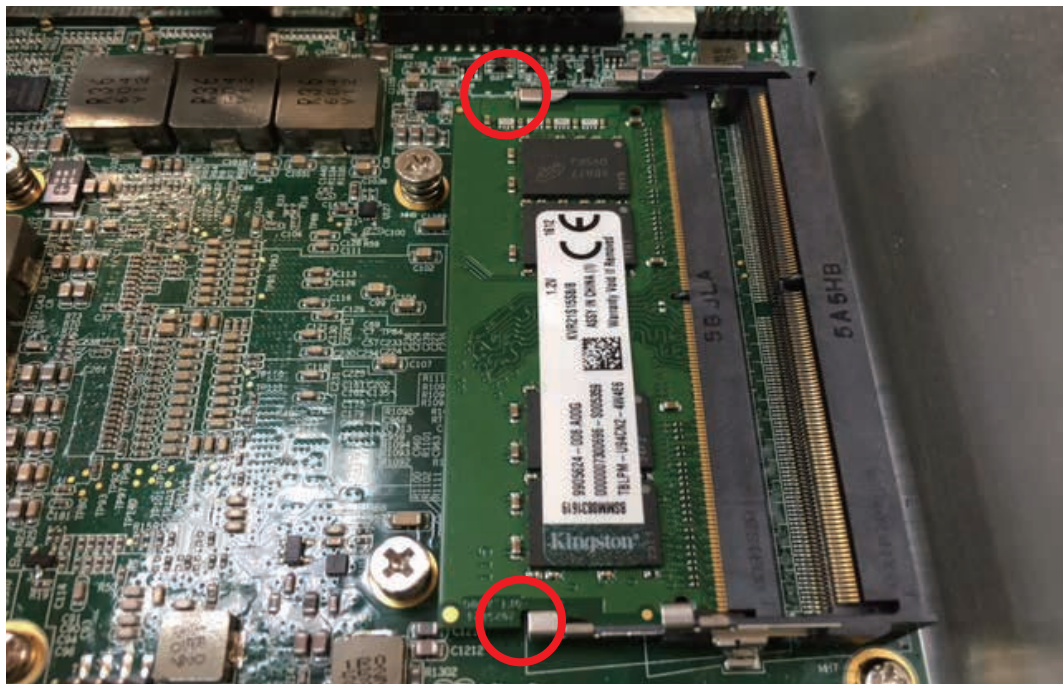

## 3.4 Installing Mini PCIe Card

**Step 1** Install Mini PCIe card into the Mini PCIe socket.



**Step 2** Fasten one M2.5 screw.



## 3.5 Installing M.2 (Key B/E/M)

### 3.5.1 Key B 2280, Key E 2230, Key M 2280

**Step 1** Install M.2 card into the M.2 slot.

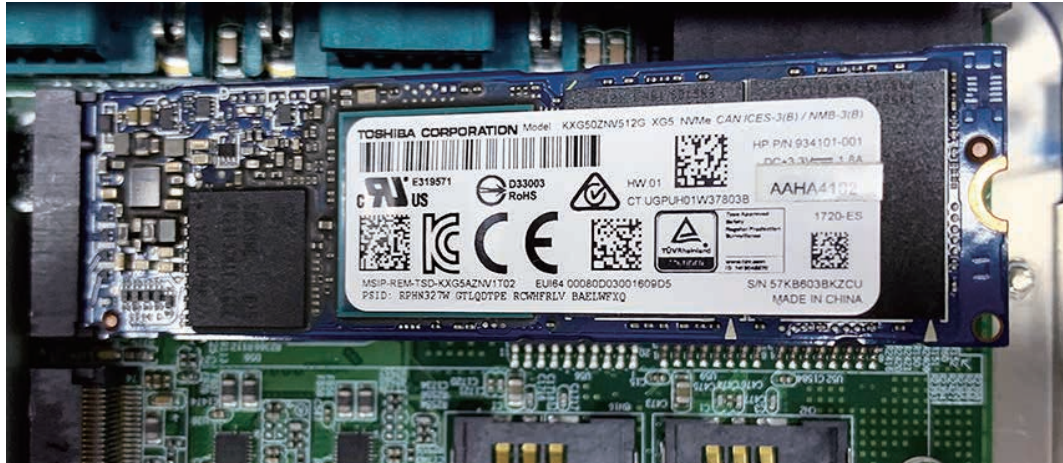

**Step 2** Fasten one PH-M3x4L screw.

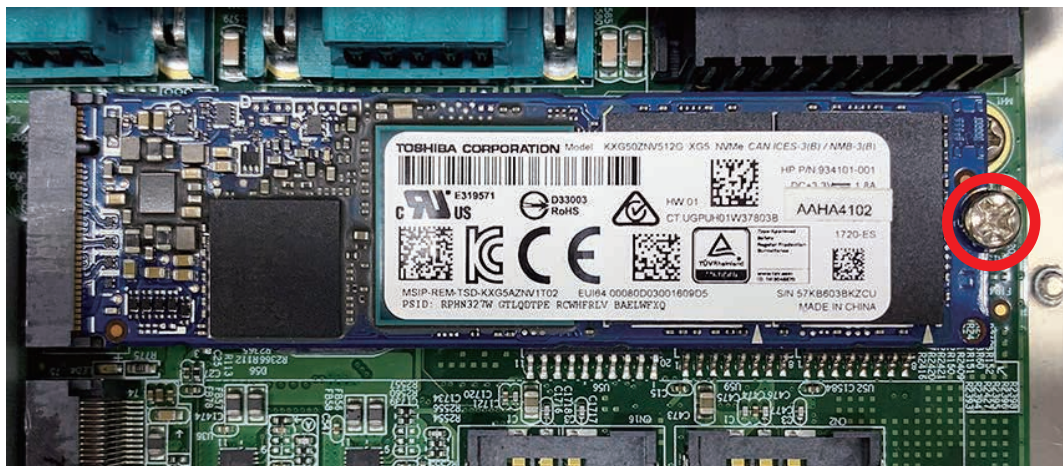

### 3.5.2 Key B 3042

**Step 1** Install M.2 card into the M.2 slot.



**Step 2** Fasten one PH-M3x4L screw.

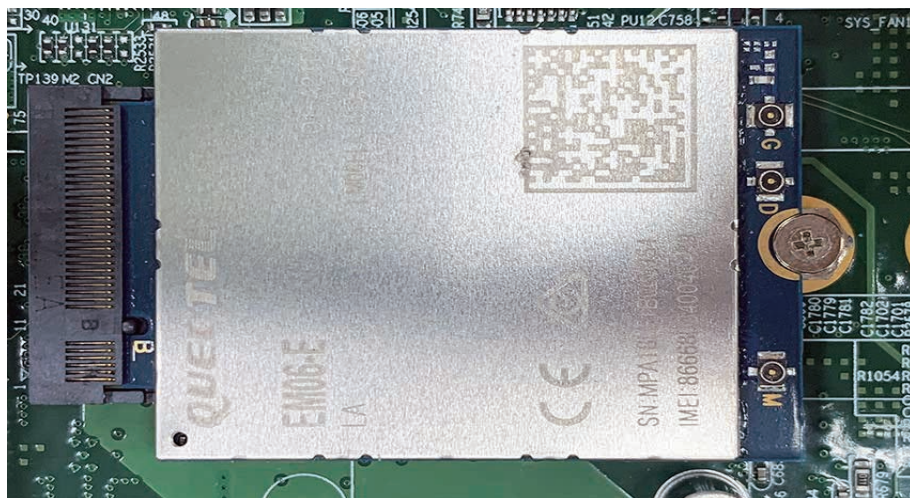

### 3.5.3 Key B 3052

**Step 1** Change the stud position.

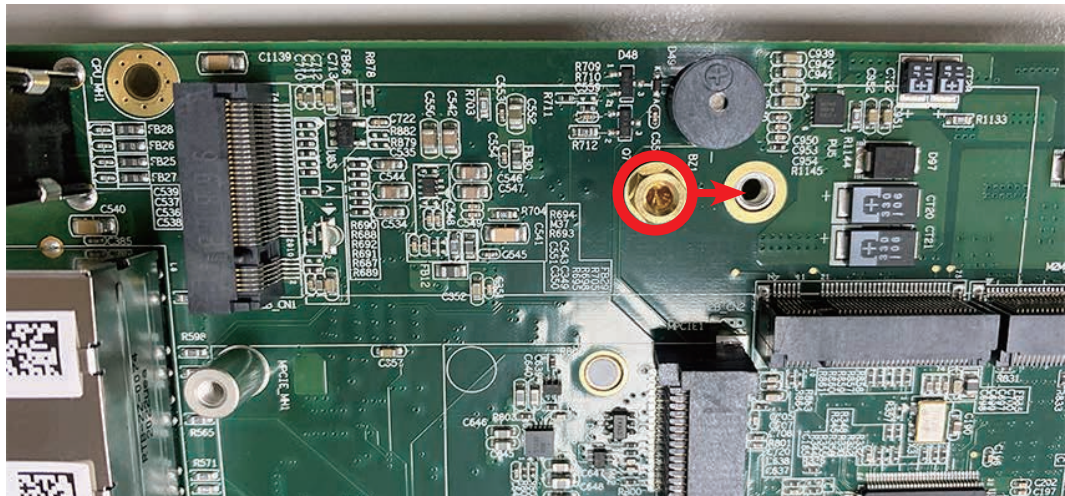

**Step 2** Then, it is able to install M.2 Key B 3052 module.

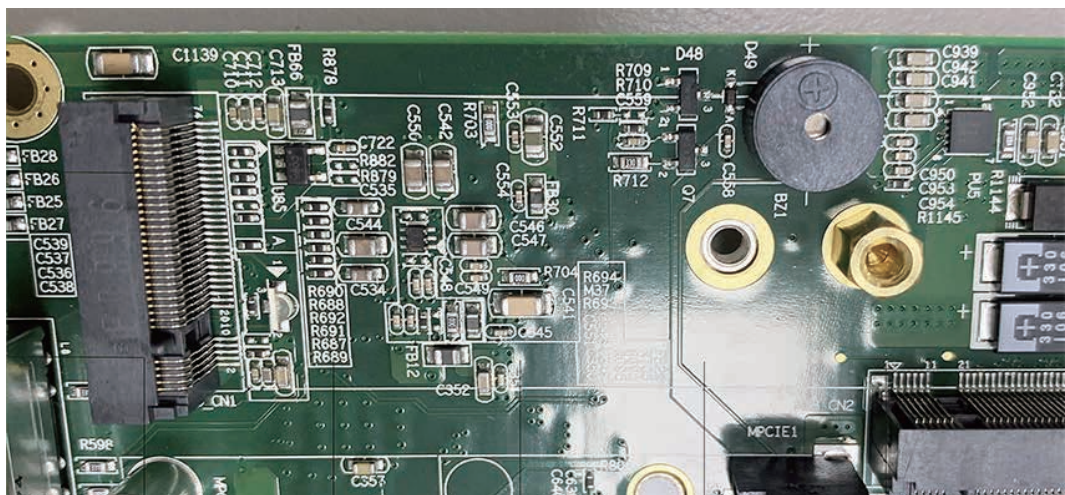

**Step 3** Install M.2 card into the M.2 slot and fasten one PH-M3x4L screw.



## 3.6 Installing Antenna Cable

**Step 1** Remove the rubber corks on the front and side.



**Step 2** Put antenna cable connector into the hole on panel.





**Step 3** Fasten washer on the antenna cable connector.



### 3.7 Installing SIM Card

**Step 1** Remove two F-M3x4L screws on SD & SIM cover.



**Step 2** Inserting SIM Card, make sure the system power is not plugged.

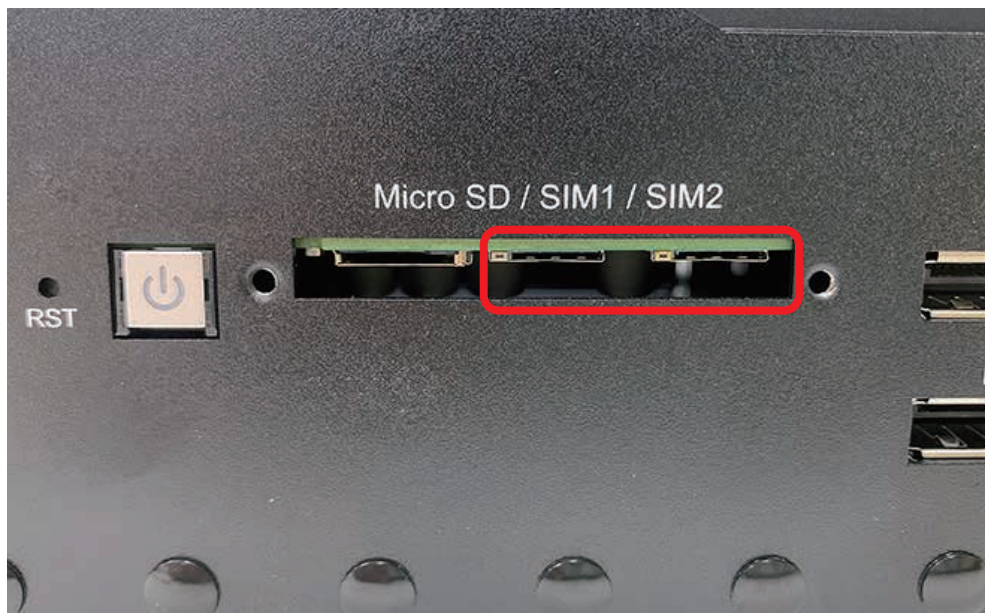

### 3.8 Installing SD Card

**Step 1** Remove two F-M3x4L screws on SD & SIM cover.



**Step 2** Inserting SIM Card, make sure the system power is not plugged.

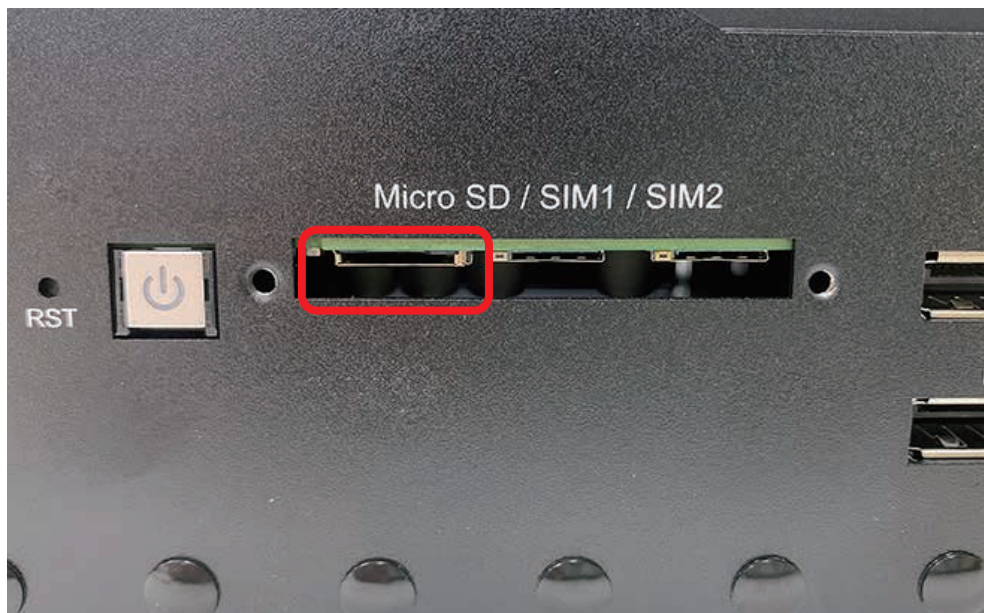

### 3.9 Installing PCI/PCIe Card

System designs will support 111.15 mm standard height, 168 mm maximum length (without the I/O bracket & power cable) expansion cards.

(\*Based on the position of power connectors and the card sink/case design, not all expansion card within the maximum dimension can fit in to the system. Please consult the Vecow support team for confirmation.)

**Step 1** Check PCI/PCIe Slot supports the maximum length 200 mm (without card bracket) of PCI/PCIe expansion card.

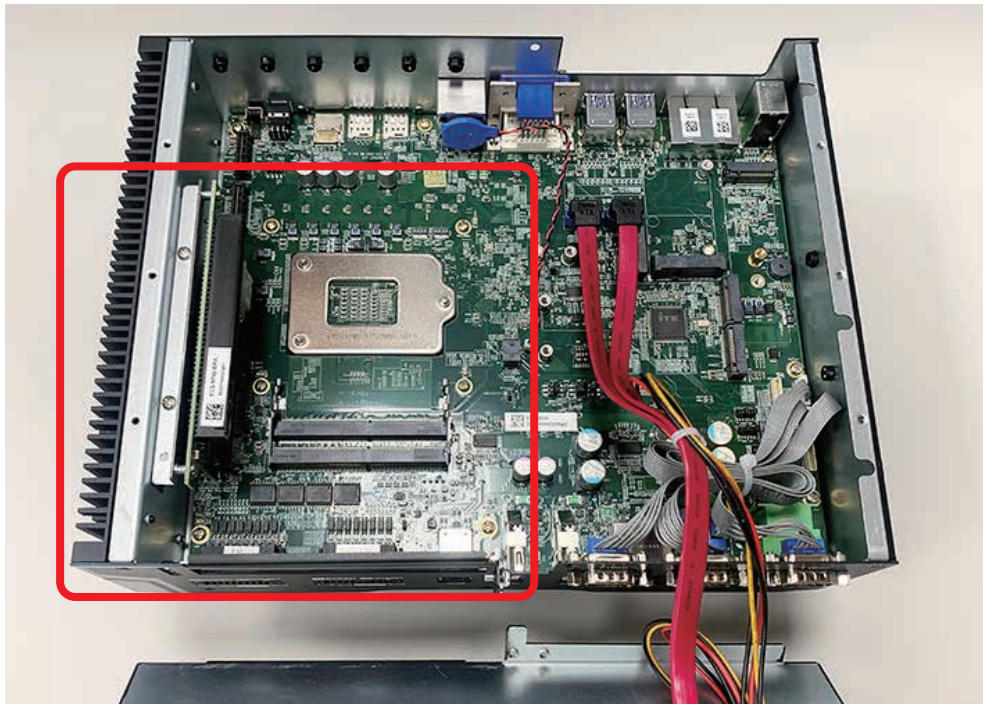

**Step 2** Remove one M3x5L and PCI bracket.



**Step 3** Installing PCI/PCIe card and fasten M3x5L screws.

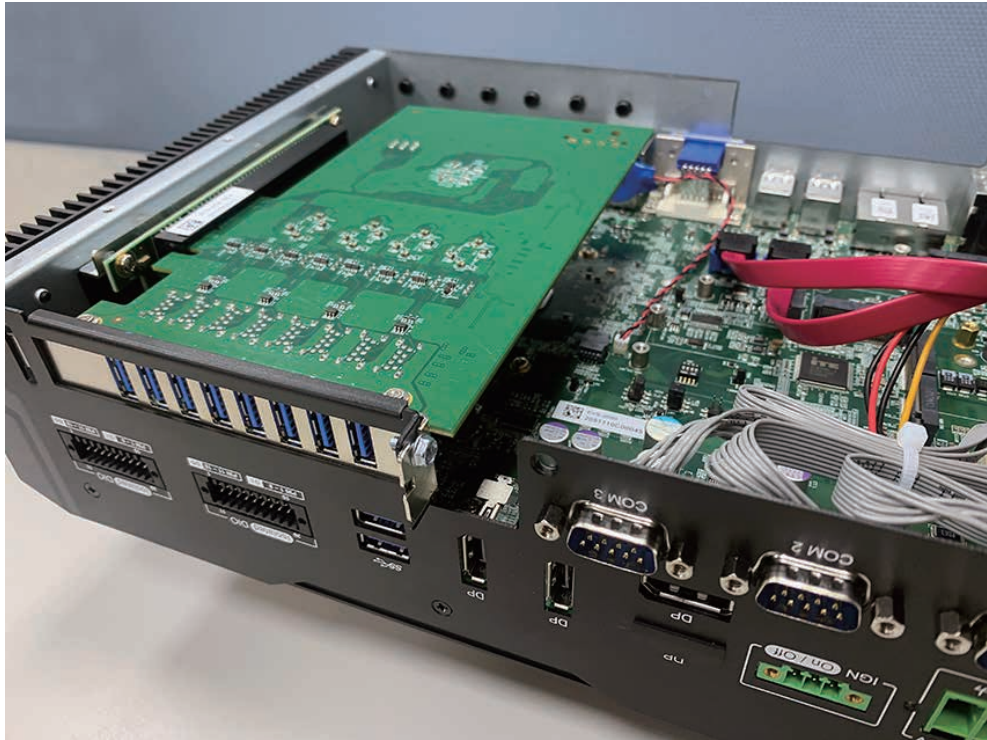

## 3.10 Installing SSD/HDD

**Step 1** Trigger and open SSD/HDD tray.



**Step 2** Insert 2.5" SSD/HDD in the tray and fasten two F-M3x4 screws.



**Step 3** Finish.

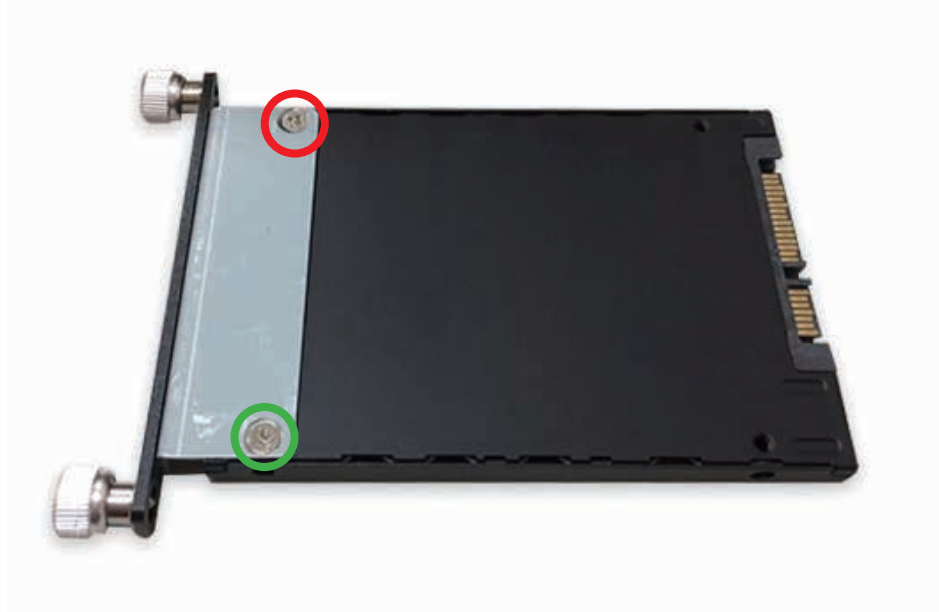

**Step 4** Installing SSD/HDD.



## 3.11 Mounting Your EVS-2000

### 3.11.1 Wall Mount Bracket for EVS-2000 with four M3x6L screws.

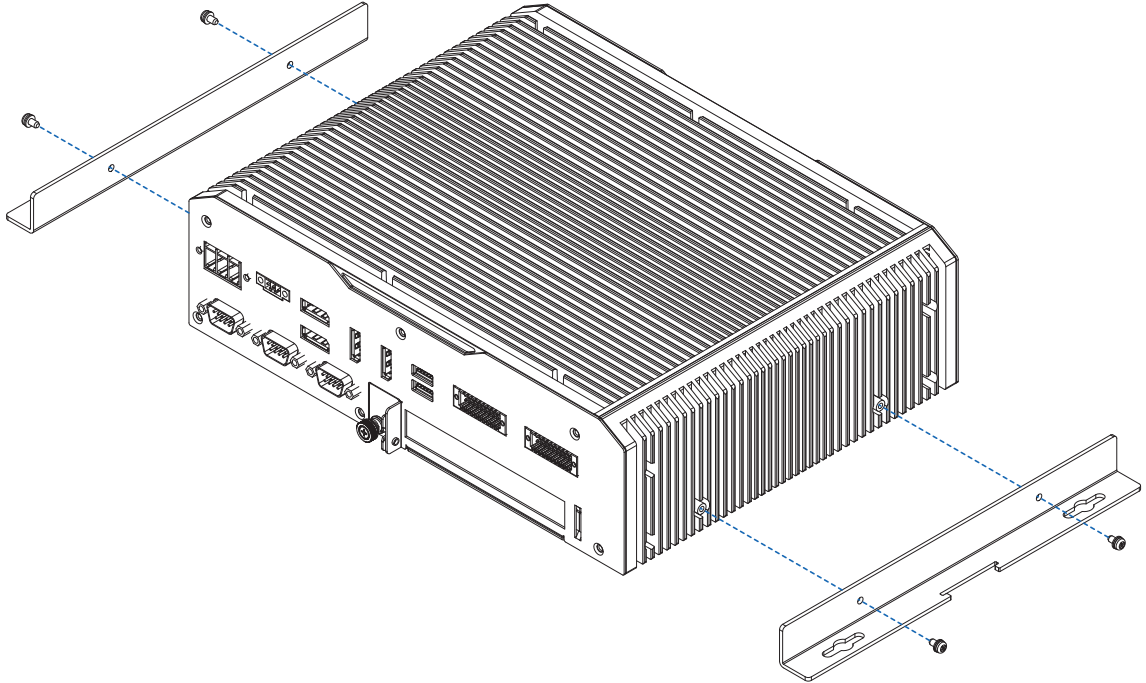

### 3.11.2 Wall Mount Bracket for EVS-2000F with four M3x6L screws.

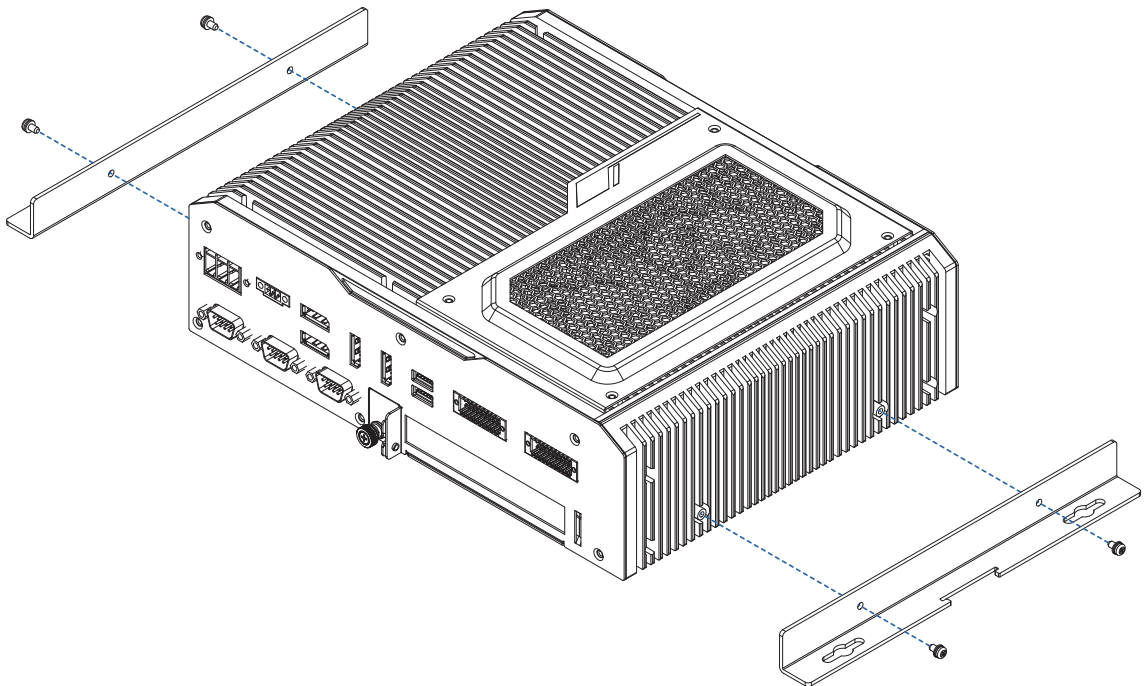



### 3.11.3 EVS-2000/2000F VESA Mount Kit (75 x 75/100 x 100 mm)

**Step 1** Remove six F-M3x6L screws.

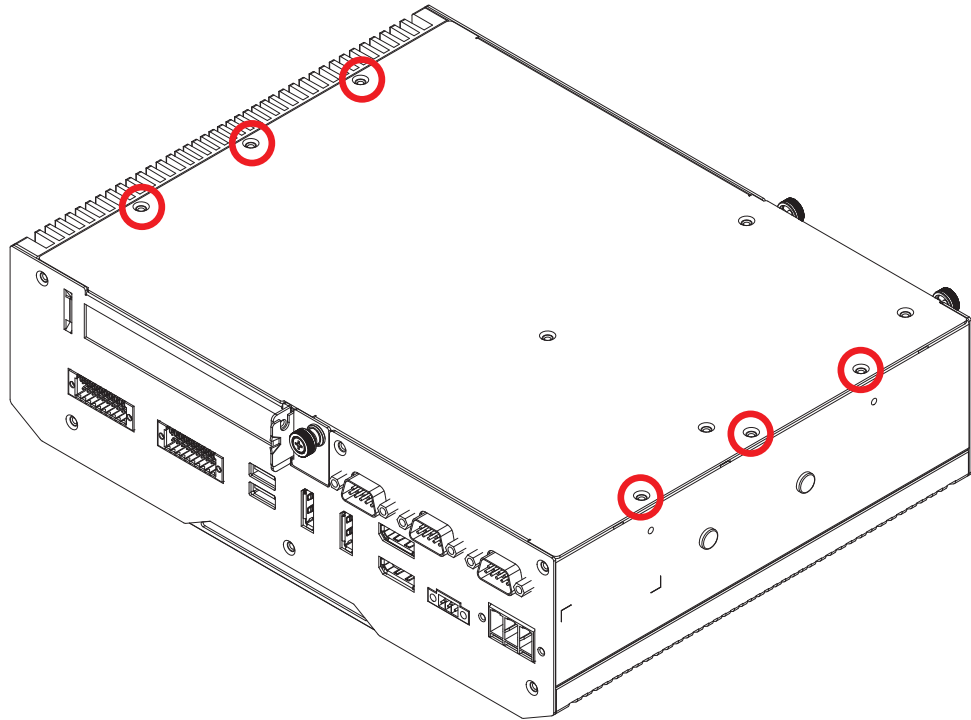

**Step 2** Install VESA Mount and fasten six I-M3x6L screws.

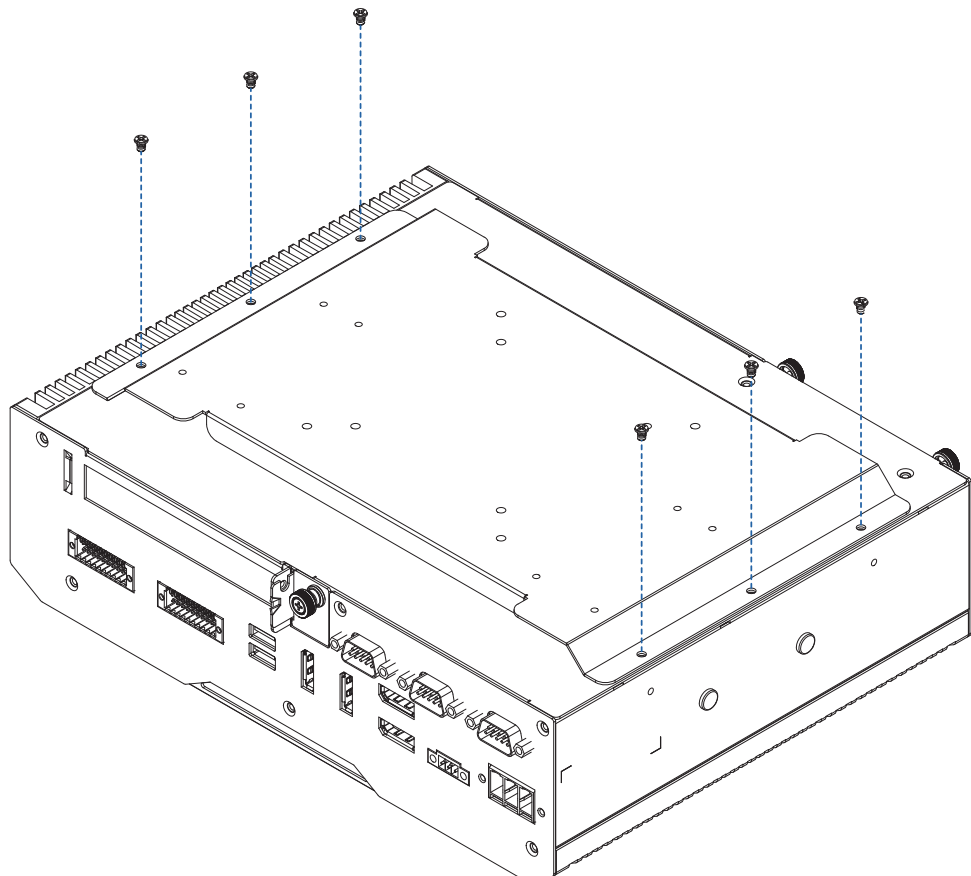

### 3.11.4 EVS-2000/2000F Din Rail with VESA Mount Kit

**Step 1** Remove six F-M3x6L screws.

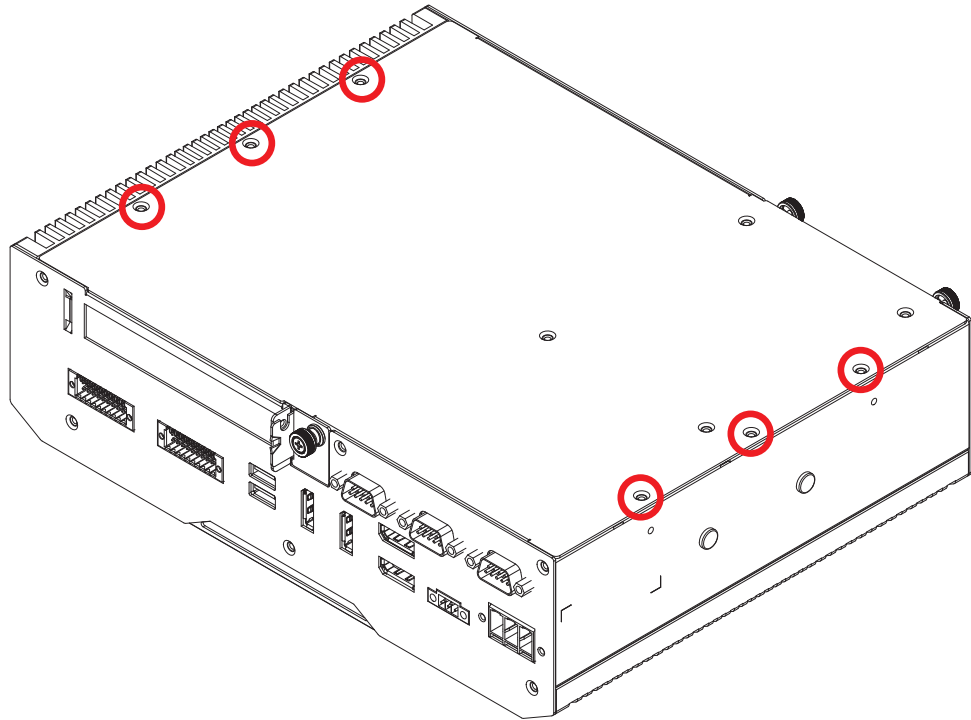

**Step 2** Install Din Rail with VESA Mount Kit and fasten six I-M3x6L screws.

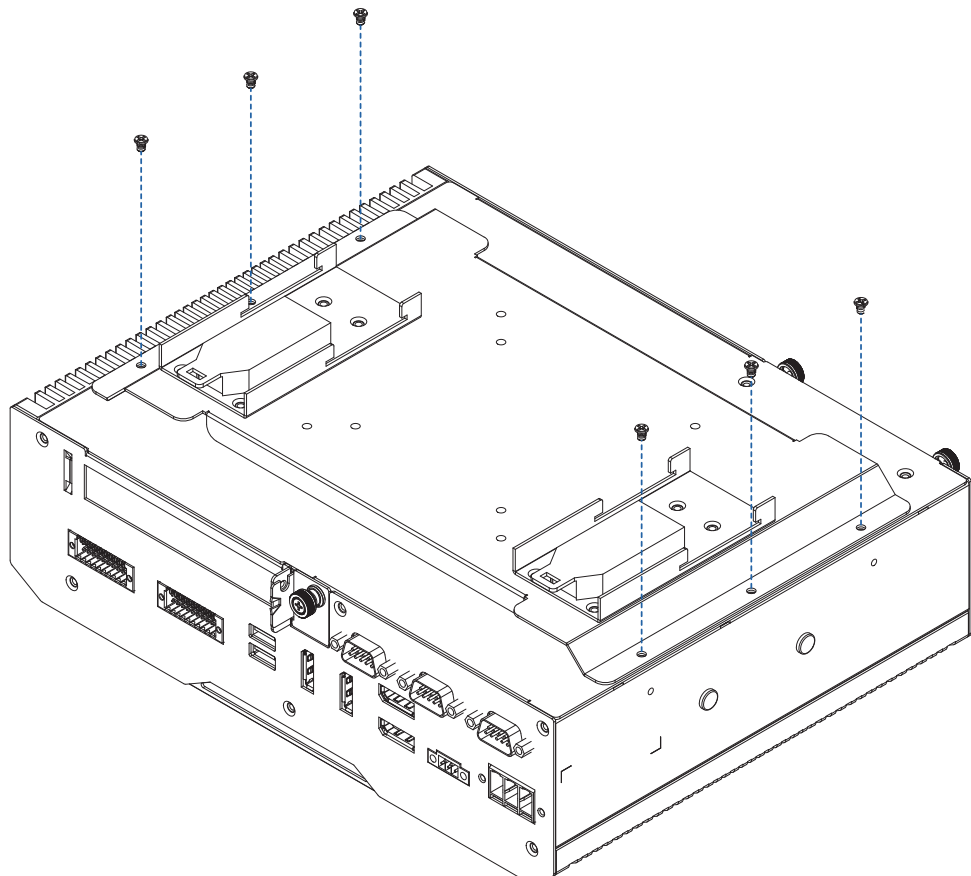

# 4

## BIOS AND DRIVER

### 4.1 BIOS Settings

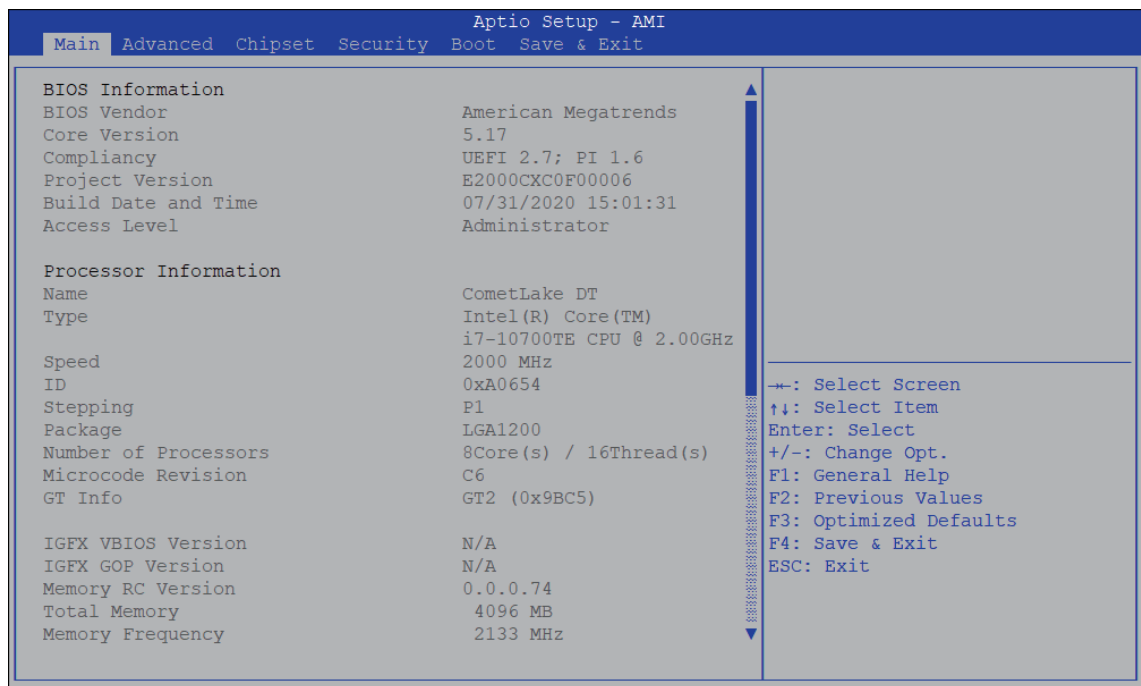

Figure 4-1 : Entering Setup Screen

BIOS provides an interface for users to check and change system configuration. The BIOS setup program is accessed by pressing the <Del> key when POST display output is shown.

## 4.2 Main

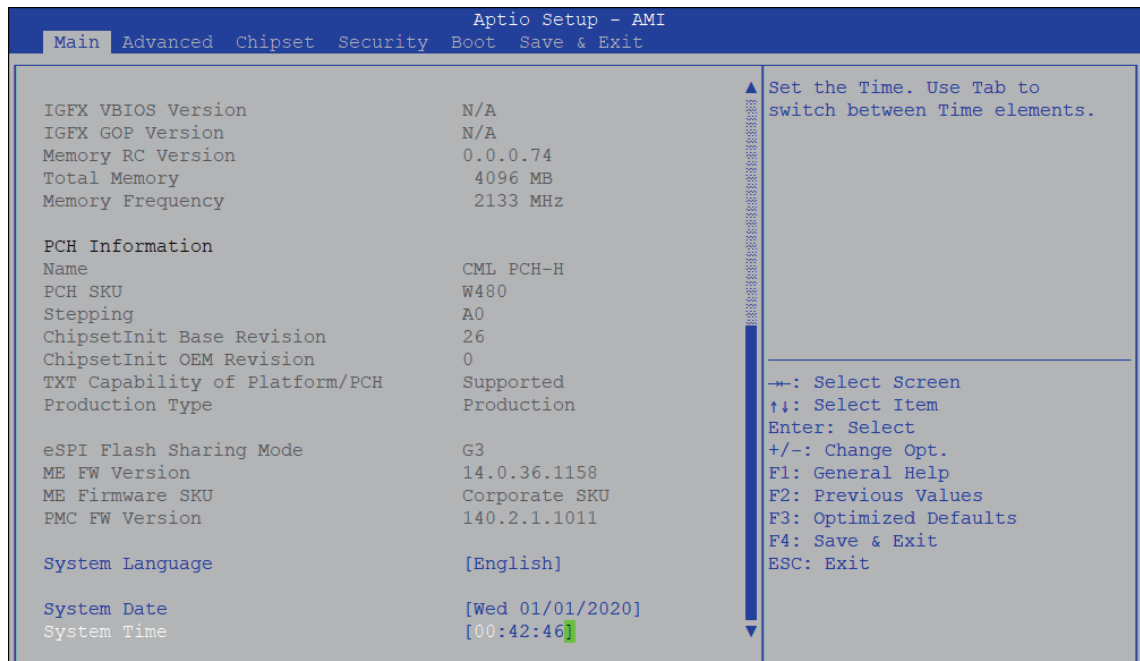

Figure 4-2 : BIOS Main Menu

The main menu displays BIOS version and system information. There are two options on Main menu.

### System Date

Set the date. Use <Tab> to switch between date elements.

### System Time

Set the time. Use <Tab> to switch between time elements.

## 4.3 Advanced

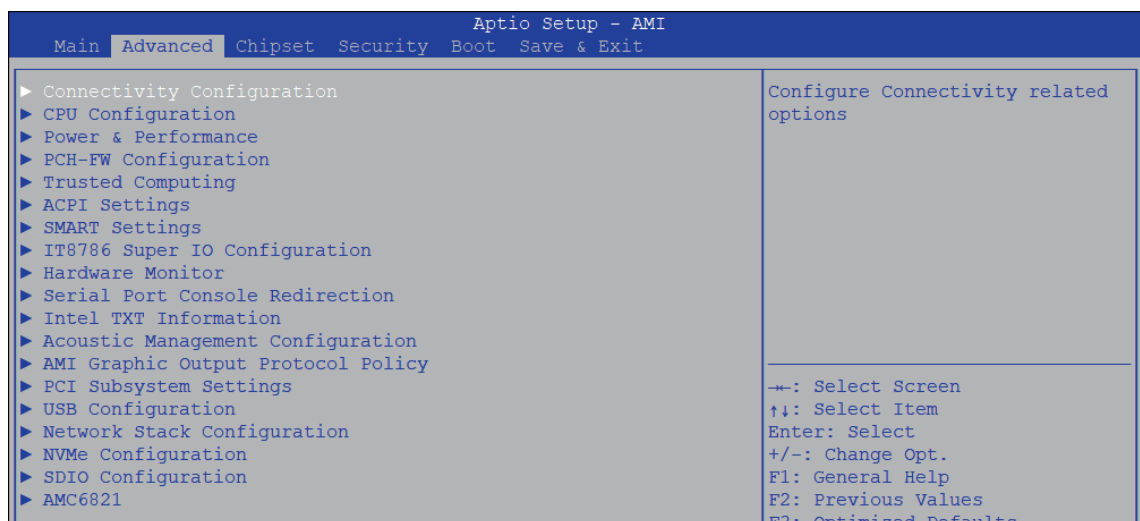

Figure 4 3 : BIOS Advanced Menu

Select advanced tab to enter advanced BIOS setup options, such as CPU configuration, SATA configuration, and USB configuration.

### 4.3.1 CPU Configuration

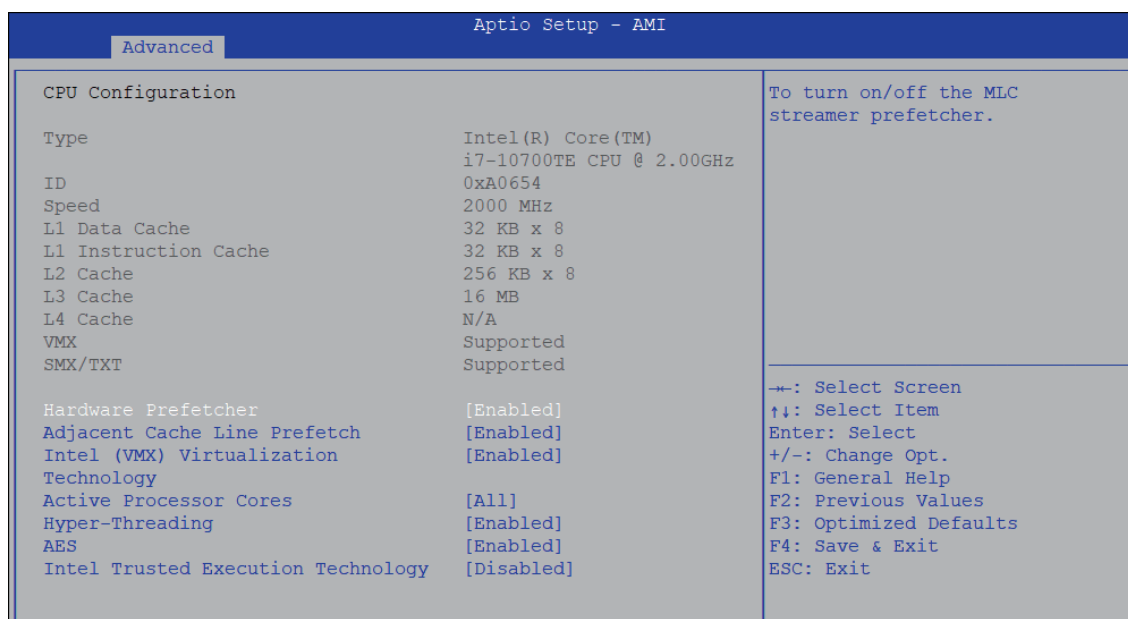

Figure 4 3-1 : CPU Configuration

#### Hardware Prefetcher

To turn on/off the MLC streamer prefetcher.

#### Adjacent Cache Line Prefetch

To turn on/off prefetching of adjacent cache lines.

#### Intel (VMX) Virtualization Technology

When enabled, a VMM can utilize the additional hardware capabilities provided by Vanderpool Technology.

#### Active Processor Cores

Number of cores to enable in each processor package.

#### Hyper-threading

Enabled for Windows XP and Linux (OS optimized for Hyper-Threading Technology) and disabled for other OS (OS not optimized for Hyper-Threading Technology). When disabled only one thread per core is enabled.

#### AES

Enable/disable CPU Advanced Encryption Standard instructions.

#### Intel Trusted Execution Technology

Enables utilization of additional hardware capabilities provided by Intel® Trusted Execution Technology.

Changes require a full power cycle to take effect.

## 4.3.2 Power & Performance

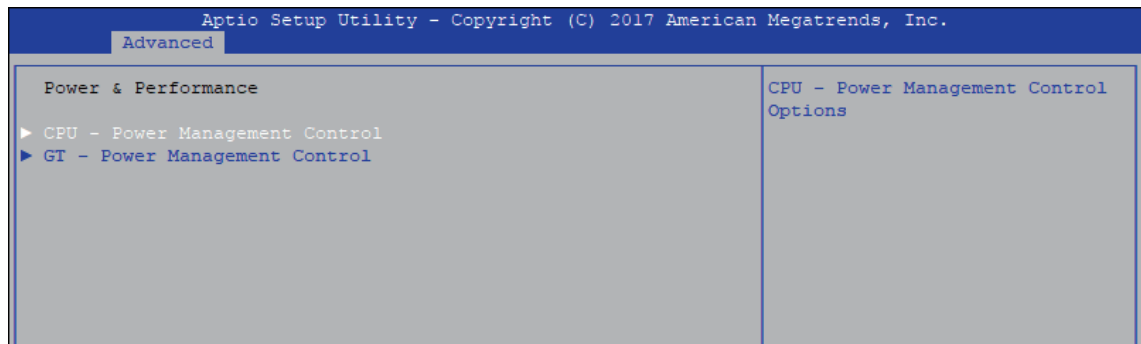

Figure 4 3-2 : Power & Performance

### 4.3.2.1 CPU – Power Management Control

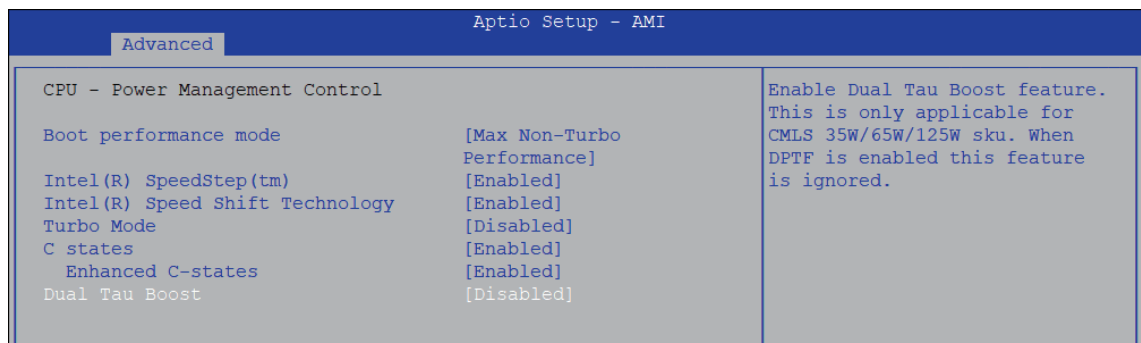

Figure 4 3-2-1 : CPU – Power Management Control

#### Boot performance mode

Select the performance state that the BIOS will set before OS handoff.

#### Intel (R) SpeedStep (tm)

Allows more than two frequency ranges to be supported.

#### Intel (R) Speed shift Technology

Enable/Disable Intel® Speed Shift Technology support. Enabling will expose the CPPCv2 interface to allow for hardware controlled P-states.

#### Turbo Mode

Turbo Mode.

#### C states

Enable or disable CPU C states.

#### Enhanced C-states

Enable/Disable C1E. When enabled, CPU will switch to minimum speed when all cores enter C-State.

#### Dual Tau Boost

Enable Dual Tau Boost feature. This is only applicable for CML-S 35W/65W/125W sku. When DPTF is enabled, this feature is ignored.

### 4.3.2.2 GT – Power Management Control



Figure 4 3-2-2 : GT – Power Management Control

#### RC6 (Render Standby)

Check to enable render standby support.

#### Maximum GT frequency

Maximum GT frequency limited by the user. Choose between 350MHz (RPN) and 1150MHz (RP0). Value beyond the range will be clopped to min/max supported by SKU

#### Disable Turbo GT frequency

Check to enable render standby support.

### 4.3.3 PCH-FW Configuration

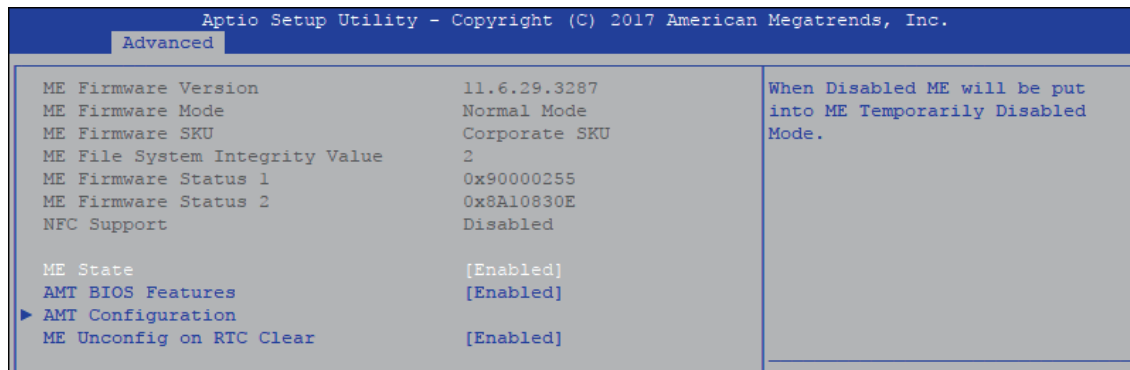

Figure 4 3-3 : PCH-FW Settings

#### ME State

Set ME to Soft temporarily disabled.

#### AMT BIOS Features

When disabled AMT BIOS Features are no longer supported and user is no longer able to access MEBx Setup.

#### AMT Configuration

Configure Intel® Active Management Technology Parameters.

#### ME Unconfig on RTC Clear State

Disabling this option will cause ME not to unconfigure on RTC clear.

### 4.3.4 Trusted Computing

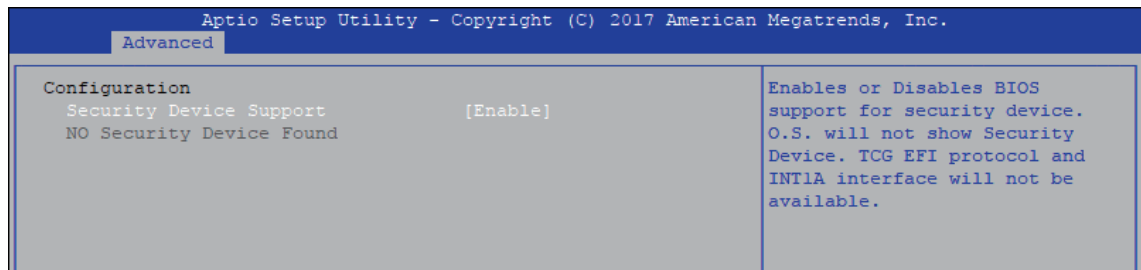

Figure 4 3-4 : Trusted Computing

Control the TPM device status and display related information if TPM chip is present.

### 4.3.5 ACPI Settings

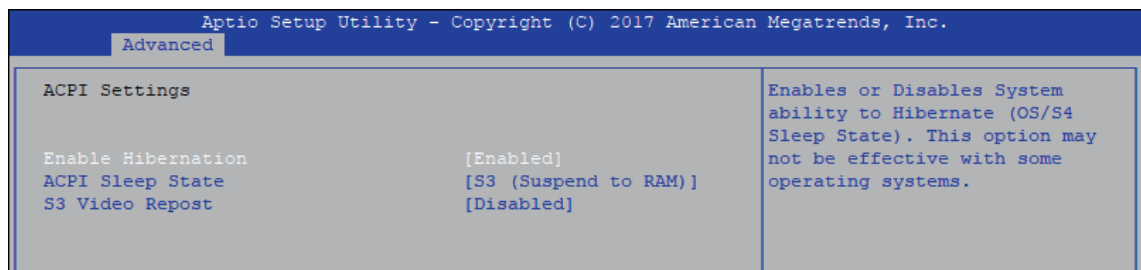

Figure 4 3-5 : ACPI Settings

#### Enable Hibernation

Enables or disables system's ability to hibernate (OS/S4 sleep state). This option may not be effective with some OS.

#### ACPI Sleep State

Selects the highest ACPI sleep state the system will enter when the SUSPEND button is pressed.

#### S3 Video Repost

Enables or disables S3 video repost.

### 4.3.6 SMART Settings

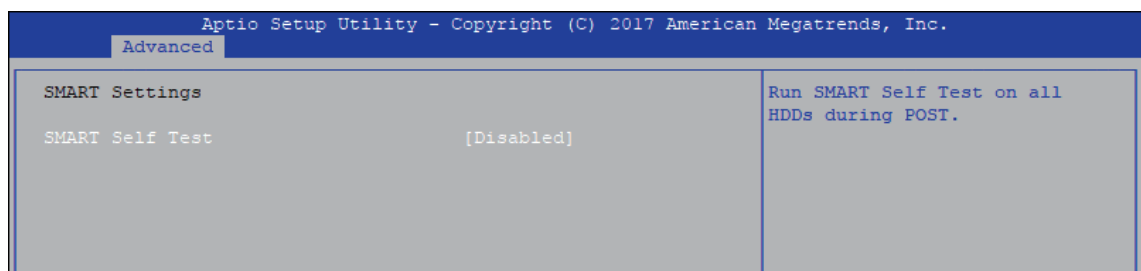

Figure 4-3-6 : SMART Settings

#### SMART Self Test

Run SMART self test on all HDDs during POST.



### 4.3.7 IT8786 Super IO Configuration

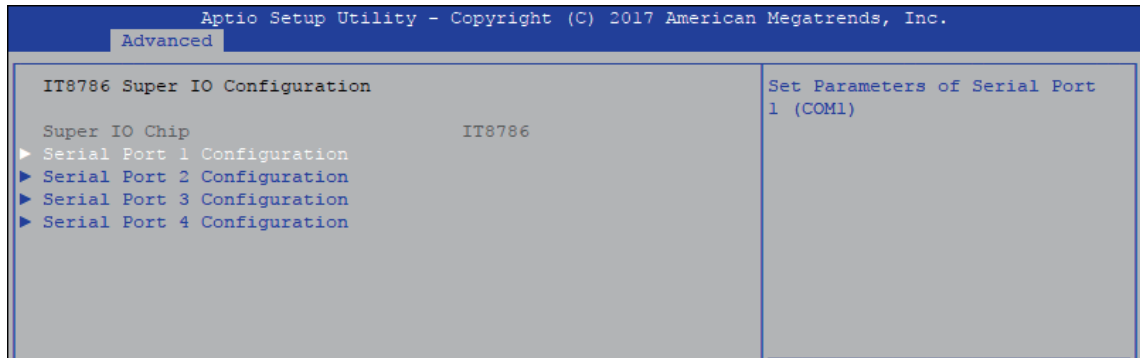

Figure 4-3-7 : IT8786 Super IO Settings

#### 4.3.7.1 Serial Port X Configuration

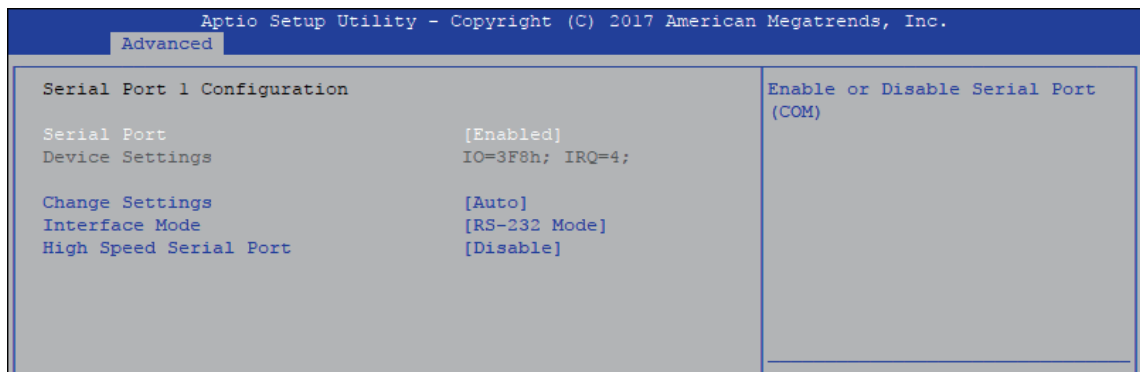

Figure 4-3-7-1 : Serial Port X Configuration

#### Serial Port 1 to port 4 Configuration

Options for Serial Port 1 to Serial Port 4.

Entering the corresponding Port option then end user can change the settings such as I/O resource and UART mode (High Speed Serial Port is Port 1 only).

## 4.3.8 Hardware Monitor

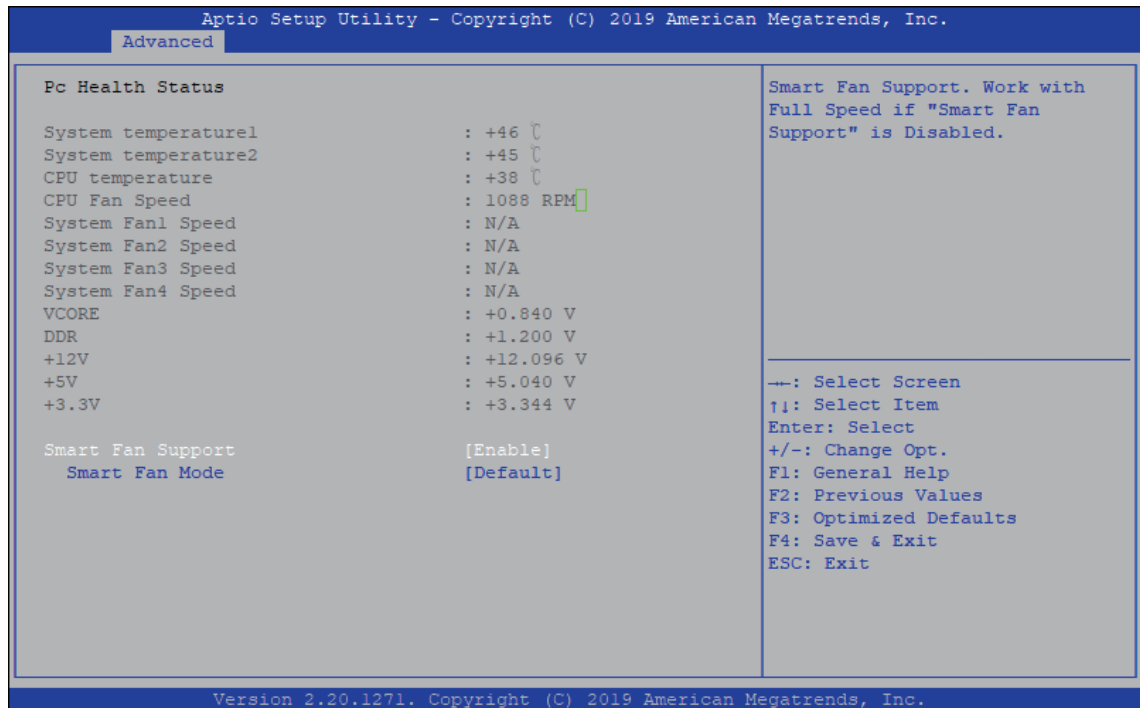

Figure 4-3-8 : Hardware Monitor Settings

The IT8786 SIO features an enhanced hardware monitor providing thermal, fan speed, and system voltages' status monitoring.

### Smart Fan Support

Smart Fan Support. Work with Full Speed if "Smart Fan Support" is Disabled.

### Smart Fan Mode

Default : Using the default smart fan table.

User : Setting parameters by user.

### Start Temperature

Temperature Limit value of Fan Start (Degree C).

(Range : 10~80)

### PWM Start Value (%)

Default PWM Value of Fan.

(Range : 15%~100%)

### Full Speed Temperature

Temperature Limit value of Fan Full Speed (Degree C).

(Range : 50~90)

### 4.3.9 Serial Port Console Redirection

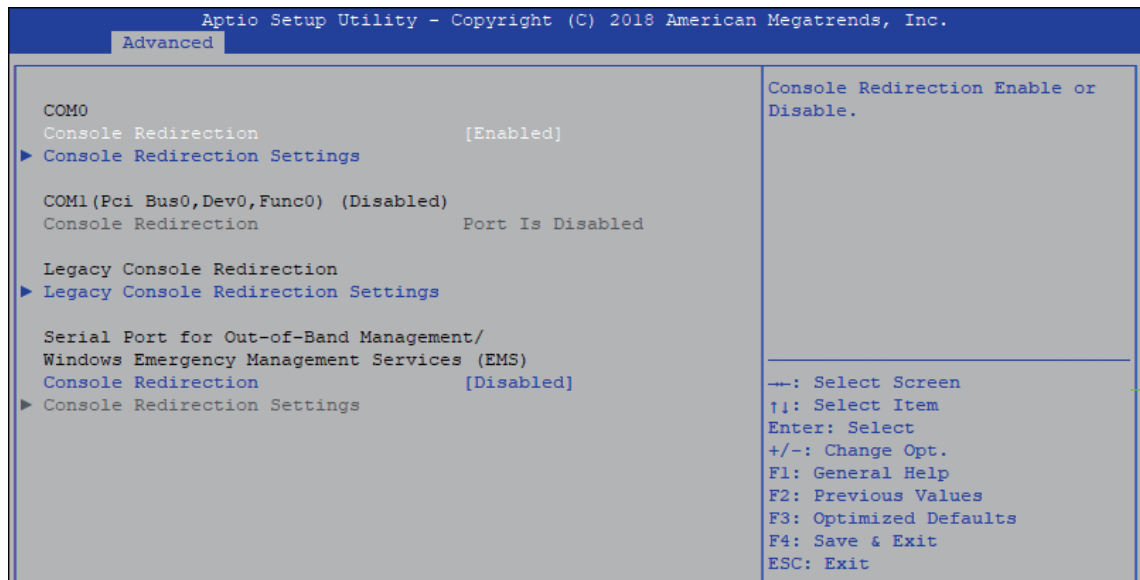

Figure 4-3-9 : Serial Port Console Redirection Settings

#### Console Redirection

Console redirection enable or disable.

#### Console Redirection Settings

These settings specify how the host computer and the remote computer (which the user is using) will exchange data. Both computers should have the same or compatible settings.

#### Legacy Console Redirection

Legacy Console Redirection Settings.

#### Serial Port for Out-of-Band Management/Windows Emergency Management Services (EMS)

Console redirection enable or disable.

### 4.3.10 Intel TXT Information



Figure 4-3-10 : Intel TXT Information

Display Intel TXT information

### 4.3.11 Acoustic Management Configuration



Figure 4-3-11 : Acoustic Management Settings

#### Acoustic Management Configuration

Option to enable or disable automatic acoustic management.

### 4.3.12 PCI Subsystem Setting

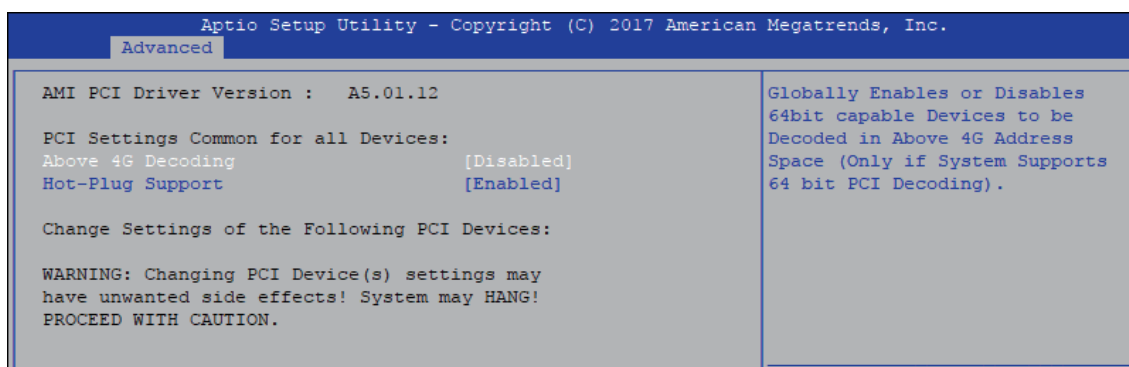

Figure 4-3-12 : PCI Subsystem Settings

#### Above 4G Decoding

Globally Enables or Disables 64-bit capable Devices to be Decoded in Above 4G Address Space (Only if System Supports bot PCI Decoding)

#### Hot-Plug Support

Globally Enables or Disables Hot-Plug support for the entire System. If system has Hot-Plug Capable Slots and this option set to Enabled, it provides a Setup screen for selecting PCI resource padding for Hot-Plug.

### 4.3.13 Network Stack Configuration

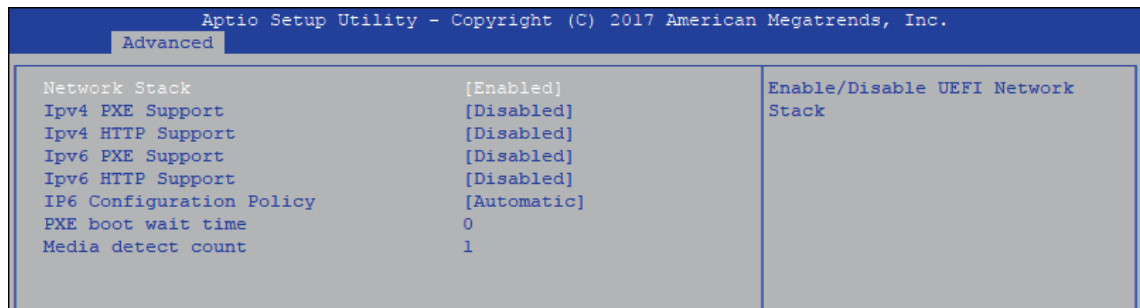

Figure 4-3-13 : Network Stack Settings

#### Network Stack

Enable/Disable UEFI Network Stack.

#### Ipv4 PXE Support

Enable/Disable IPv4 PXE boot support.

#### Ipv4 HTTP Support

Enable/Disable IPv4 HTTP boot support.

#### Ipv6 PXE Support

Enable/Disable IPv6 PXE boot support.

#### Ipv6 HTTP Support

Enable/Disable IPv6 HTTP boot support.

#### IP6 Configuration Policy

Set IP6 Configuration Policy.

#### PXE boot wait time

Wait time to press ESC key to abort the PXE boot.

#### Media detect count

Number of times presence of media will be checked.

### 4.3.14 AMC6821 Configuration

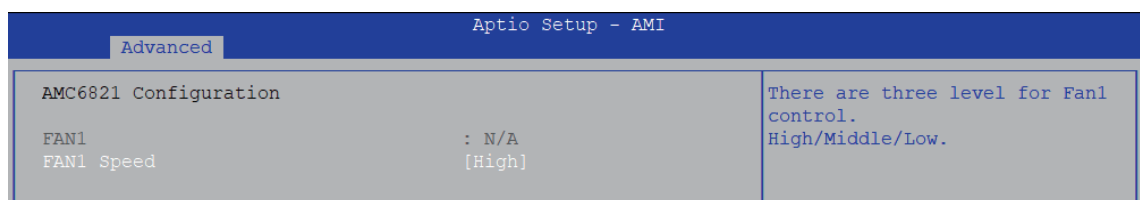

Figure 4-3-14 : AMC6821 Settings

#### Fan1 Speed

There are three level for Fan1 Control.  
[High/Middle/Low]

### 4.3.15 NVMe Configuration

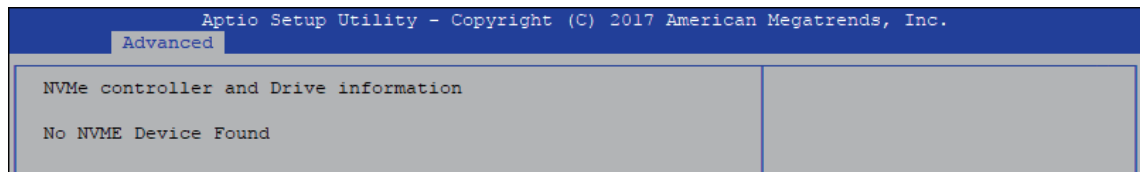

Figure 4-3-15 : NVMe Settings

Display NVMe controller and Drive information.

### 4.3.16 USB Configuration

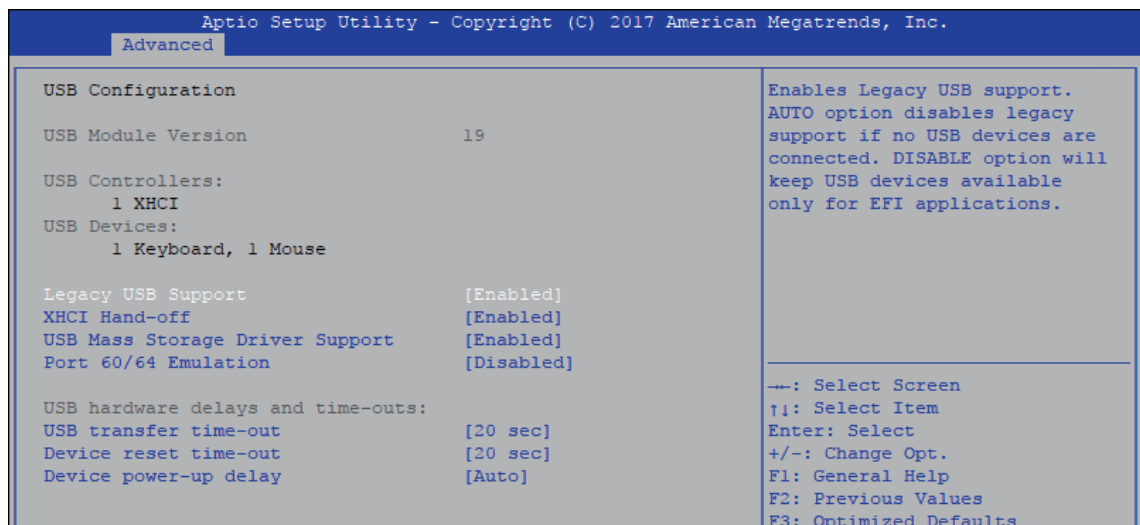

Figure 4-3-16 : USB Settings

#### Legacy USB Support

Enables Legacy USB support.

AUTO option disables Legacy support if no USB devices are connected. DISABLE option will keep USB devices available only for EFI applications.

#### XHCI Hand-off

This is a workaround for OS-es without XHCI hand-off support. The XHCI ownership change should be claimed by XHCI driver.

#### USB Mass Storage Driver Support

Enable/disable USB mass storage driver support.

#### Port 60/64 Emulation

Enables I/O port 60h/64h emulation support. This should be enabled for the complete USB keyboard legacy support for non-USB aware OSes.

#### USB transfer time-out

The time-out value for control, bulk, and interrupt transfers.

#### Device reset time-out

USB mass storage device start unit command time-out.

#### Device power-up delay

Maximum time the device will take before it properly reports itself to the Host Controller. 'Auto' uses default value, for a root port it is 100 ms, for a hub port the delay is taken from the hub descriptor.

## 4.3.17 Connectivity Configuration

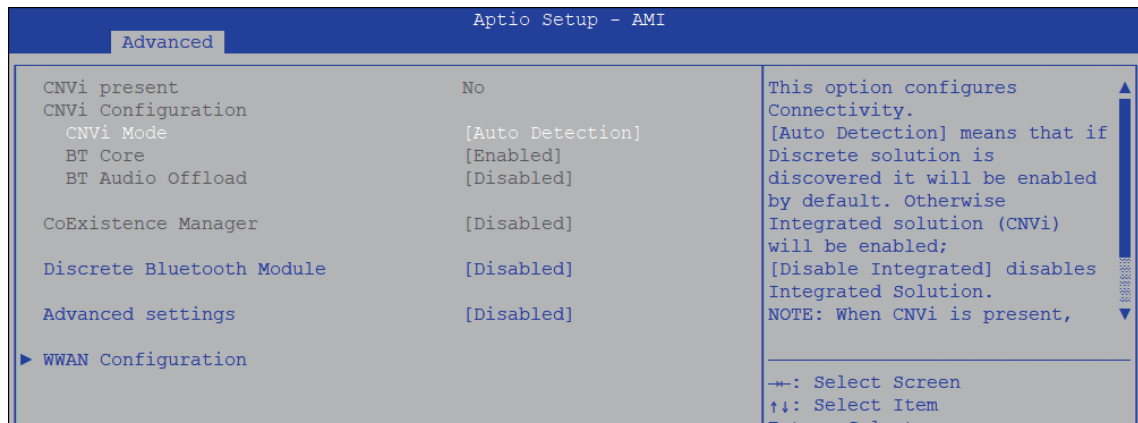

Figure 4-3-17 : Connectivity Settings

### CNVi present

[Yes] means CNVi is the active Connectivity Solution,  
[No] means CNVi was not discovered.

### CNVi Mode

This option configures Connectivity.

[Auto Detection] means that if Discrete solution is discovered it will be enabled by default. Otherwise Integrated solution (CNVi) will be enabled;

[Disable Integrated] disables Integrated Solution.

NOTE : When CNVi is present, the GPIO pins that are used for radio interface cannot be assigned to the other native function.

### BT Core

This is an option intended to Enable/Disable BT Core in CNVi

### BT Audio Offload

This is an option to Enable/Disable BT Audio Offload which enables audio input from BT device in HFP format to the audio DSP and enables power efficient audio output to BT device via A2DP format.

This feature only support with Intel(R) Wireless-AX 22560

### CoExistence Manager

CoEx Manager mitigates radio coexistence issues between Intel WWAN (modem) and Intel WLAN (WiFi/BT).

This should be enabled only if both WWAN and WLAN solutions are based on Intel components.

### Discrete Bluetooth Module

Seriallo UART0 needs to be enabled to select BT Module

### Advanced settings

Configure ACPI objects for wireless devices

### WWAN Configuration

Configure WWAN related options

## 4.3.18 SDIO Configuration

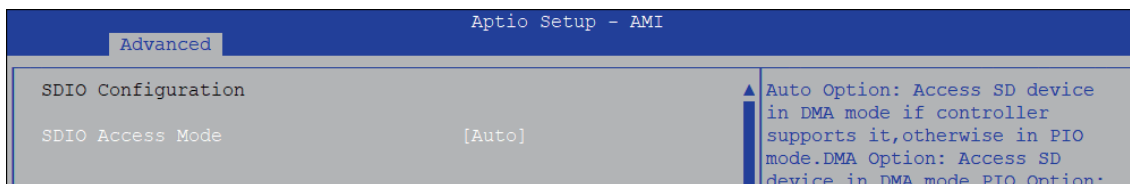

Figure 4-3-18 : SDIO Settings

### SDIO Access Mode

[Auto] : Access SD device in DMA mode if controller supports it, otherwise in PIO mode.

[DMA] : Access SD device in DMA mode.

[PIO] : Access SD device in PIO mode.



## 4.4 Chipset

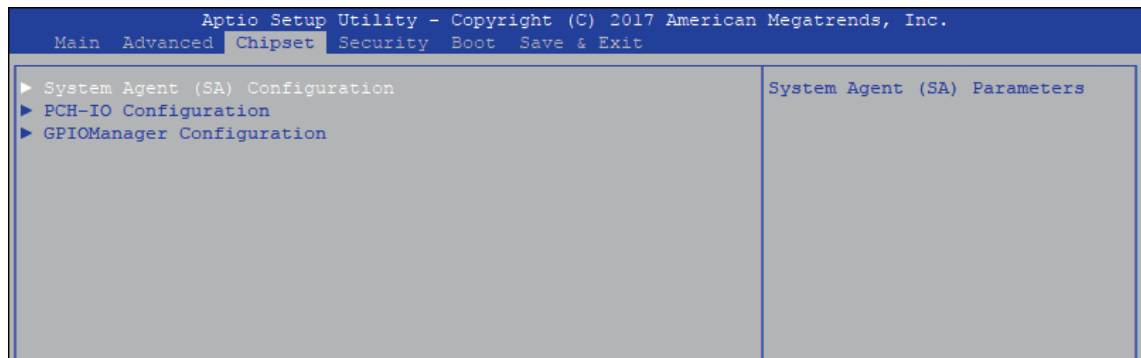

Figure 4-4 : BIOS Chipset Menu

### System Agent (SA) Configuration

System Agent (SA) parameters.

### PCH-IO Configuration

PCH parameters.

### GPIOManager Configuration

GPIOManager Configuration.

### 4.4.1 System Agent (SA) Configuration

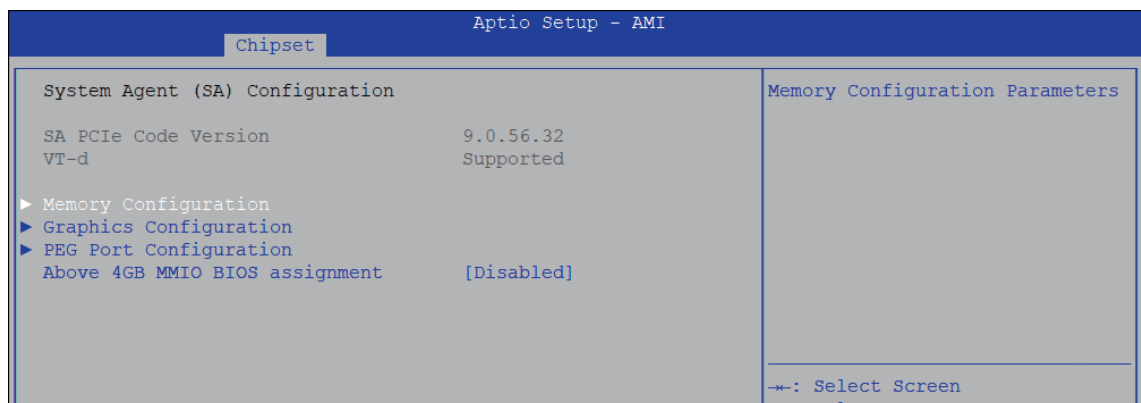

Figure 4-4-1 : System Agent Settings

### VT-d

VT-d capability.

### Above 4GB MMIO BIOS assignment

Enable/disable above 4GB MemoryMappedIO BIOS assignment. This is disabled automatically when aperture size is set to 2048MB.

### 4.4.1.1 Memory Configuration

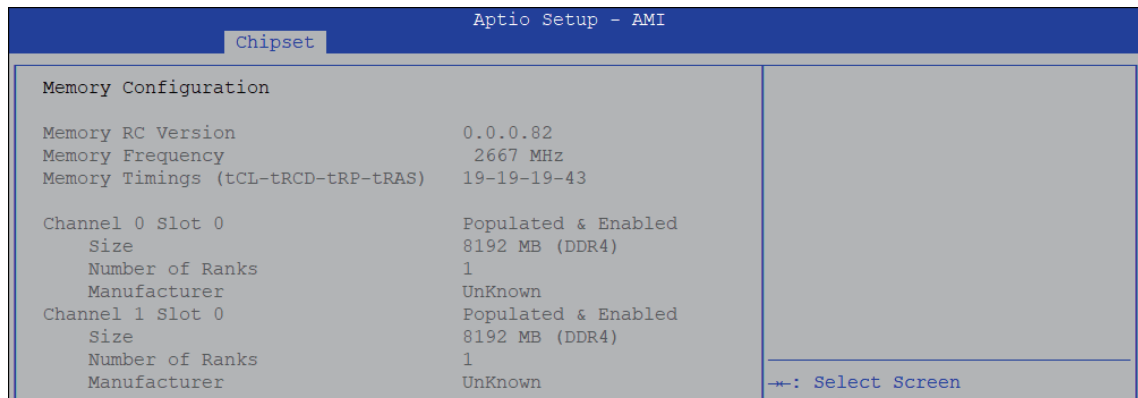

Figure 4-4-1-1 : Memory Information

Displays memory information.

### 4.4.1.2 Graphics Configuration

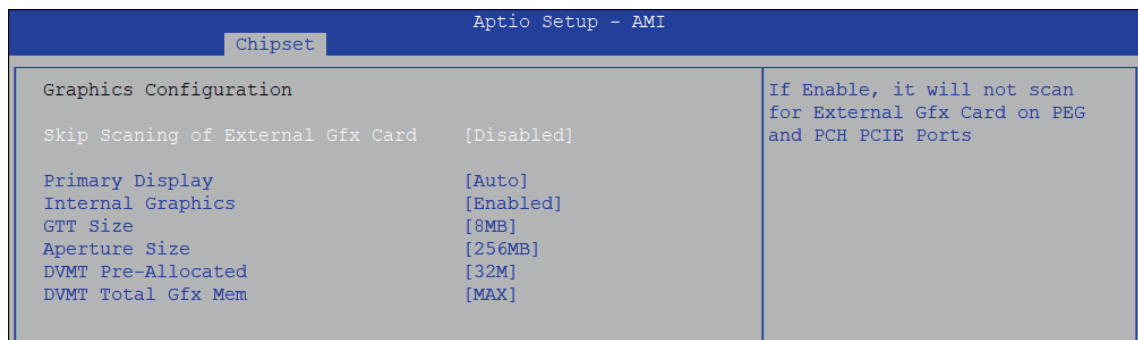

Figure 4-4-1-2 : Graphics Settings

#### Skip Scanning of External Gfx Card

If Enable, it will not scan for External Gfx Card on PEG and PCH PCIE Ports.

#### Primary Display

Select which of IGFX/PEG/PCI Graphics device should be Primary Display Or select SG for Switchable Gfx.

#### Internal graphics

Keep IGFX enabled based on the setup options.

#### GTT Size

Select the GTT Size.

#### Aperture Size

Select the Aperture Size.

Note : Above 4GB MMIO BIOS assignment is automatically enabled when selecting 2048MB aperture. To use this feature, please disable CSM Support.

#### DVMT Pre-Allocated

Select DVMT 5.0 Pre-Allocated (Fixed) Graphics Memory size used by the Internal Graphics Device.

#### DVMT Total Gfx Mem

Select DVMT5.0 Total Graphic Memory size used by the Internal Graphics Device.

### 4.4.1.3 PEG Port Configuration

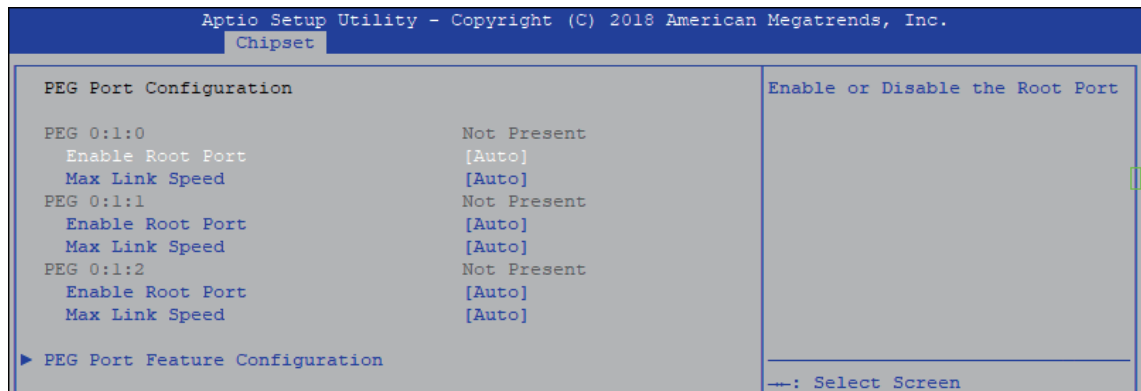

Figure 4-4-1-3 : PEG Port Configuration

PEG port options for PCIe device.

### 4.4.2 PCH-IO Configuration

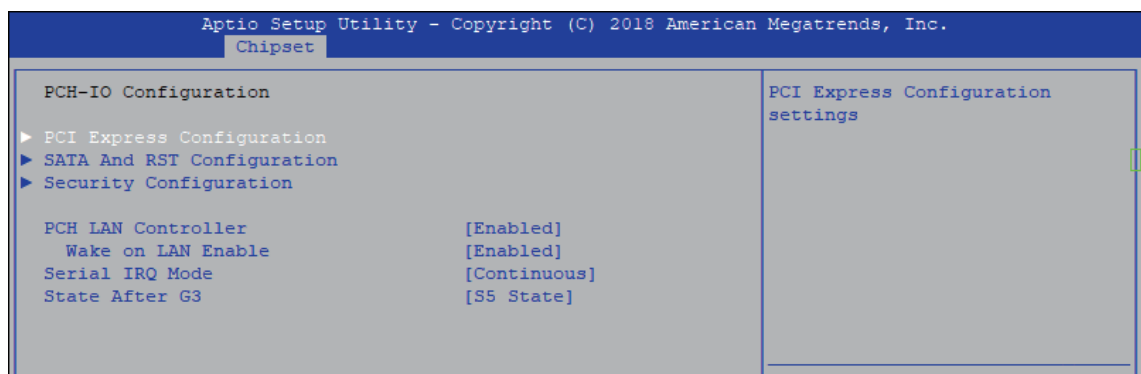

Figure 4-4-2 : PCH-IO Settings

#### PCH LAN Controller

Enable or disable onboard NIC.

#### Wake on LAN

Enable or disable integrated LAN to wake the system. (The wake On LAN cannot be disabled if ME is on at Sx state.)

#### Serial IRQ Mode

Configure serial IRQ mode.

#### State After G3

Specify what state to go to when power is re-applied after a power failure (G3 state).

S0 State : Always turn-on the system when power source plugged-in.

S5 State : Always turn-off the system when power source plugged-in.

## 4.4.2.1 PCI Express Configuration of PCH-IO

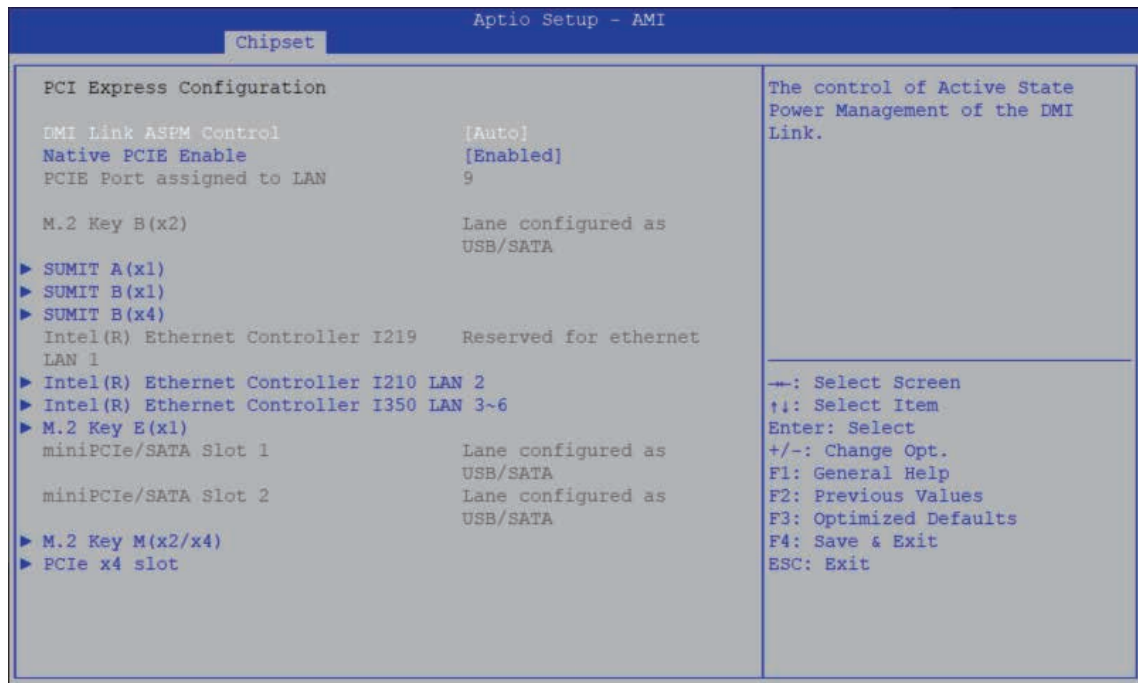

Figure 4-4-2-1 : PCH-IO Settings

### DMI Link ASPM Control

Enable/Disable the control of Active State Power Management on SA side of the DMI Link.

### Native PCIE Enable

PCIE Express Native Support Enable/Disable.

### PCI Express device settings

Bios options for PCI Express device setting.

## 4.4.2.2 SATA and RST Configuration

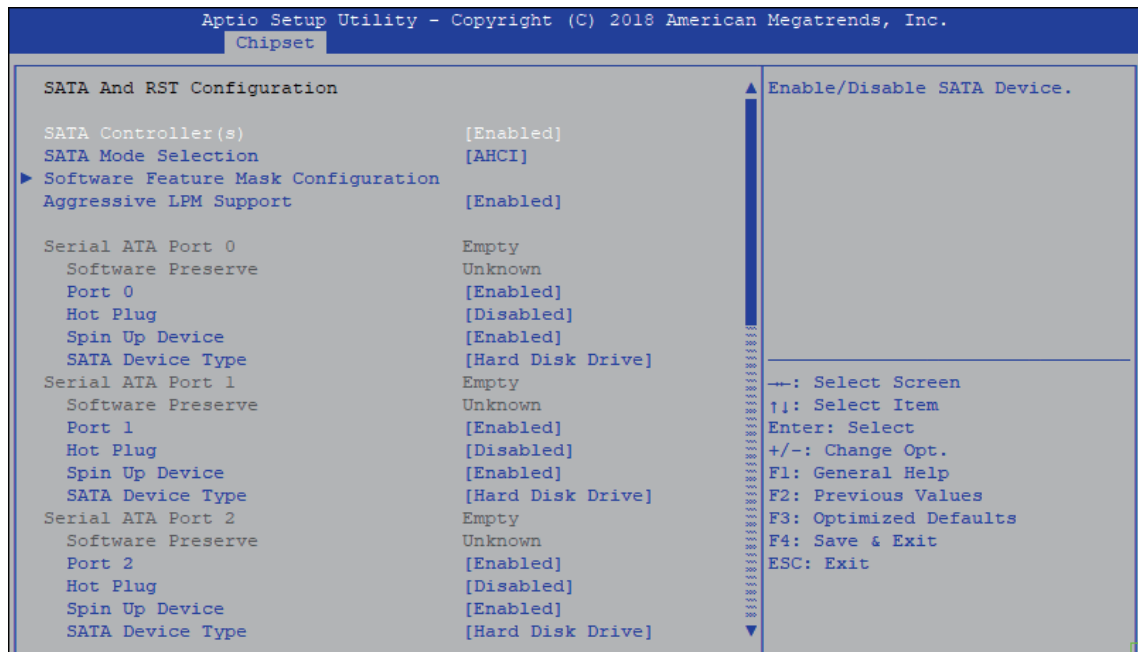

Figure 4-4-2-2 : SATA And RST Settings

### SATA Controller (s)

Enable or disable SATA Device.

### SATA Mode Selection

Determines how SATA controller (s) operate.

### Software Feature Mask Configuration

RAID OROM/RST driver will refer to the SWFM configuration to enable or disable the storage features.

### Aggressive LPM Support

Enable PCH to aggressively enter link power state.

### Options for each SATA port :

Port n

Enable or disable SATA Port.

### Hot Plug

Designated this port as Hot Pluggable.

### Spin Up Device

On an edge detect from 0 to 1, the PCH starts a COMRESET initialization sequence to the device.

### SATA Device Type

Identifies that the SATA port is connected to solid state drive or hard disk drive.

## 4.4.2.3 Security Configuration

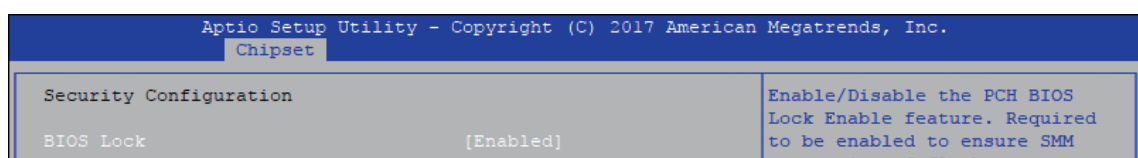

Figure 4-4-2-3 : Security Settings

### BIOS Lock

Enable/Disable the PCH BIOS Lock Enable (BLE bit) feature.

### 4.4.3 GPIOManager Control

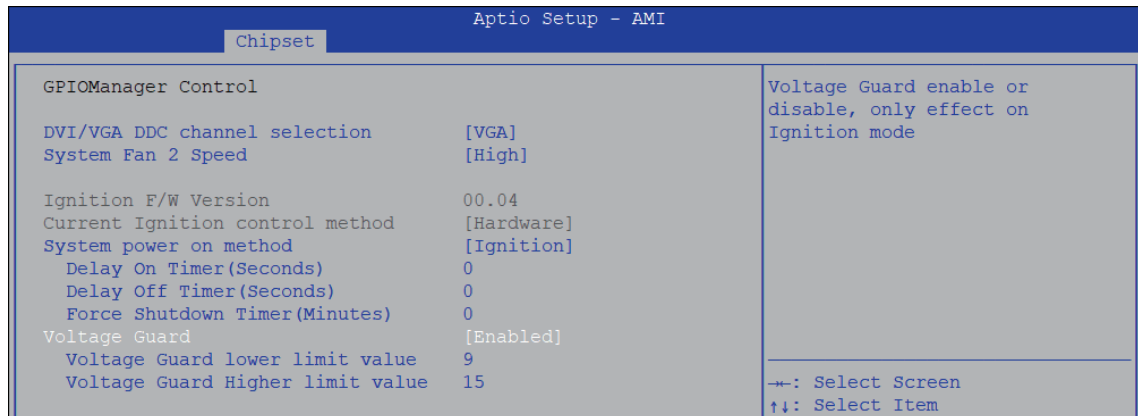

Figure 4-4-3 : GPIOManager Settings

#### DVI/VGA DDC channel selection

DVI/VGA DDC channel selection for DVI-I connector

#### System Fan 2 Speed

System Fan 2 Speed control (SYS\_FAN2)

#### Ignition F/W Version

Indicate current ignition f/w version

#### Current Ignition control method

[Hardware] Ignition mode control by hardware switch.

[Software] Ignition mode control by software

#### System power on method

[Normal] System power on by power button

[Ignition] System power on by ignition pin

#### Delay On Timer (Second)

The delay times after user trigger ignition on signal

#### Delay Off Timer (Second)

The delay times after user trigger ignition off signal

#### Force Shutdown Timer (Minutes)

Used to force cut off system power when OS unable gracefully shutdown system successfully.

#### Voltage Guard

Voltage Guard enable or disable, only effect on ignition mode.

#### Voltage Guard lower limit value

Voltage Guard lower limit value setting

range : 9V~40V\*

#### Voltage Guard Higher limit value

Voltage Guard Higher limit value setting

range : 15V~50V

\* As there will be a voltage drop between the power supply and the load, the Voltage Guard lower limit value shall not be set to the selected voltage of DC-input.

## 4.5 Security

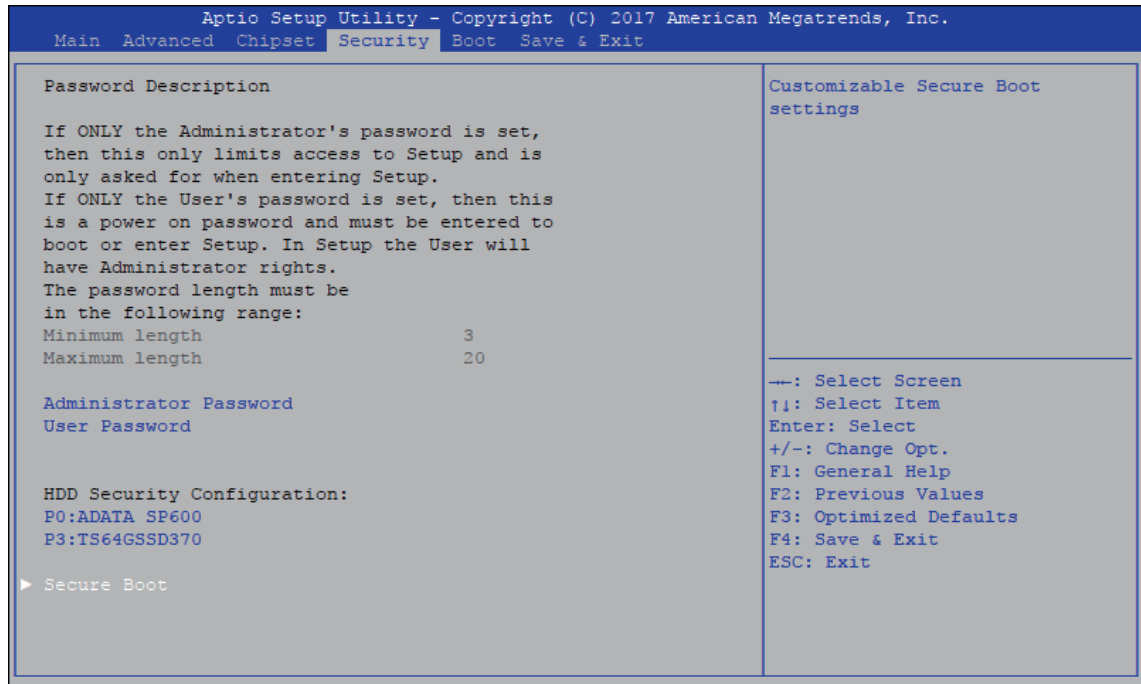

Figure 4-5 : BIOS Security Menu

### Administrator Password

Set administrator password.

### User Password

Set user password.

### Secure Boot

Customizable Secure Boot Settings.

## 4.5.1 HDD Security Configuration

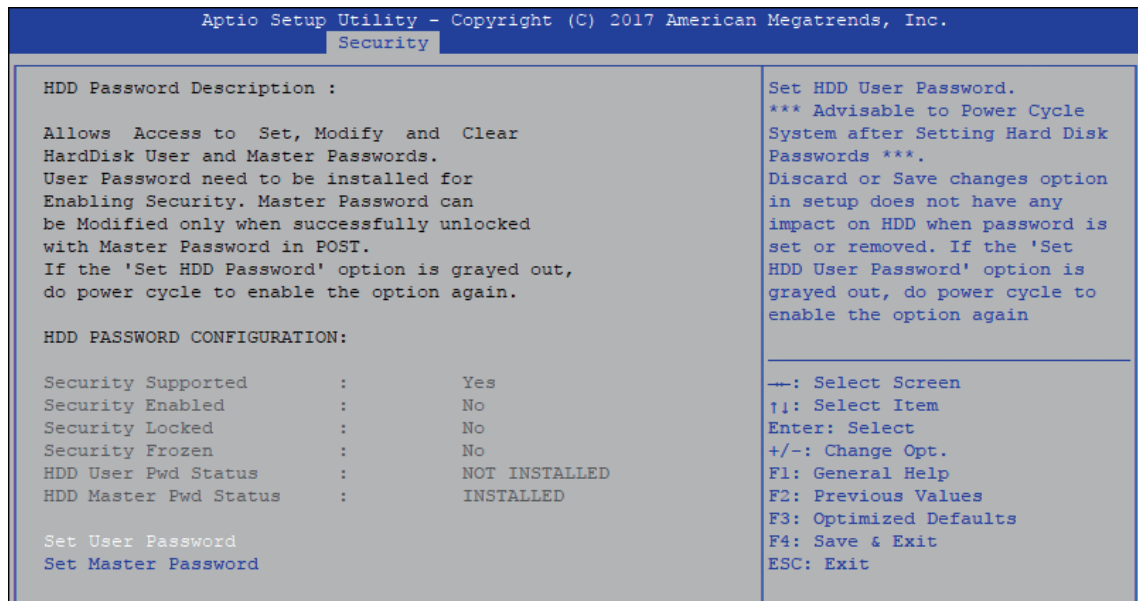

Figure 4-5-1 HDD Security Settings

### Set User Password

Set HDD user password.

\*\*\* Advisable to power cycle system after setting hard disk passwords \*\*\*

Discard or save changes option in setup does not have any impact on HDD when password is set or removed. If the 'Set HDD User Password' option is gray, do power cycle to enable the option again.

## 4.5.2 Security Boot

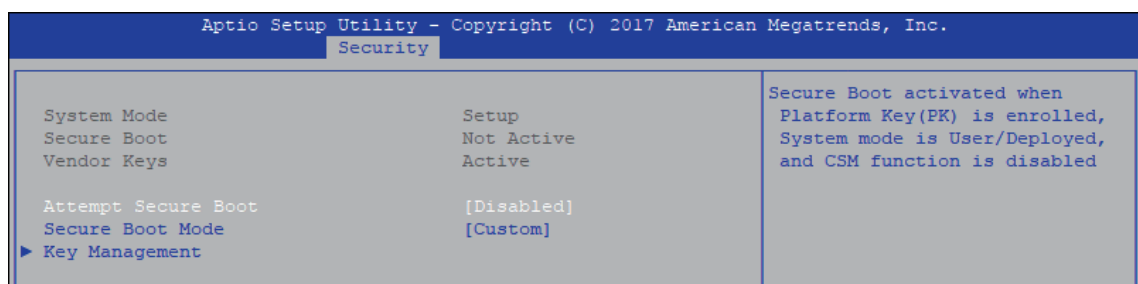

Figure 4-5-2 Security Boot Settings

### Attempt Secure Boot

Secure Boot activated when Platform Key (PK) is enrolled, System mode is User/Deployed, and CSM function is disabled.

### Secure Boot Mode

Secure Boot mode selector Standard/Custom.

In custom mode Secure Boot Variables can be configured without authentication.

### Key Management

Enables expert users to modify Secure boot policy variables without full authentication.



## 4.6 Boot

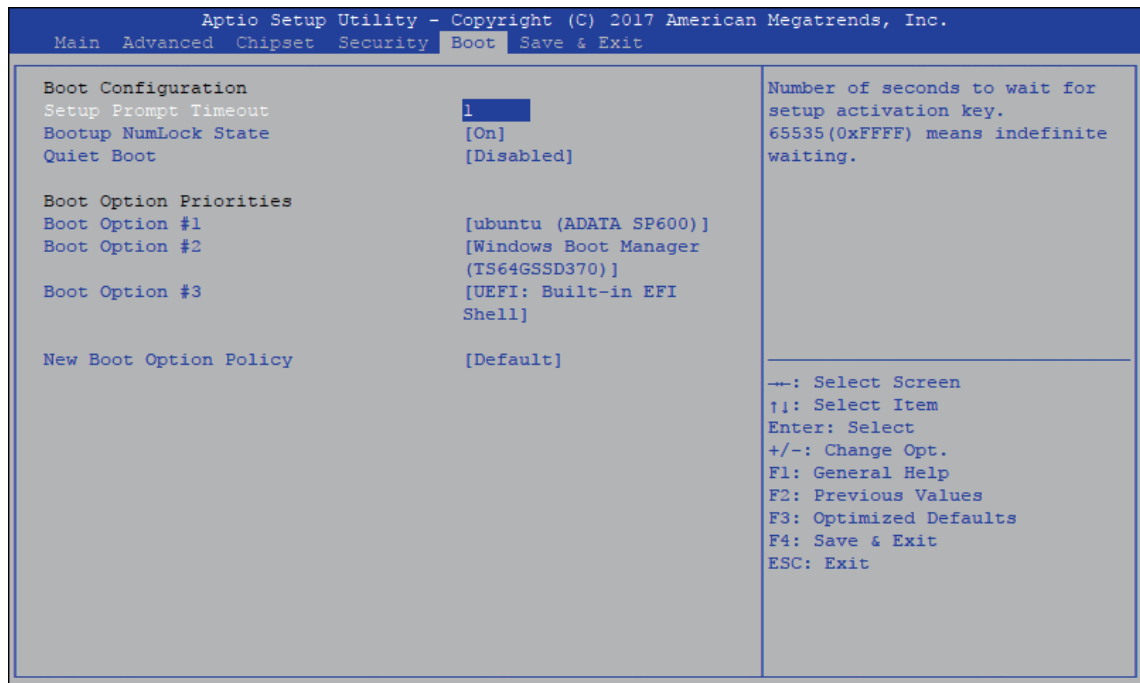

Figure 4-6 : BIOS Boot Menu

### Setup Prompt Timeout

Number of seconds to wait for setup activation key. 65535 (0xFFFF) means indefinite waiting.

### Bootup NumLock State

Select the keyboard NumLock state.

### Quiet Boot

Enables or disables Quiet Boot option.

### Boot Option

Sets the system boot order.

### New Boot Option Policy

Controls the placement of newly detected UEFI boot options.

### Hard Drive BBS Priorities

Set the order of the Legacy devices in this group.

## 4.7 Save & Exit

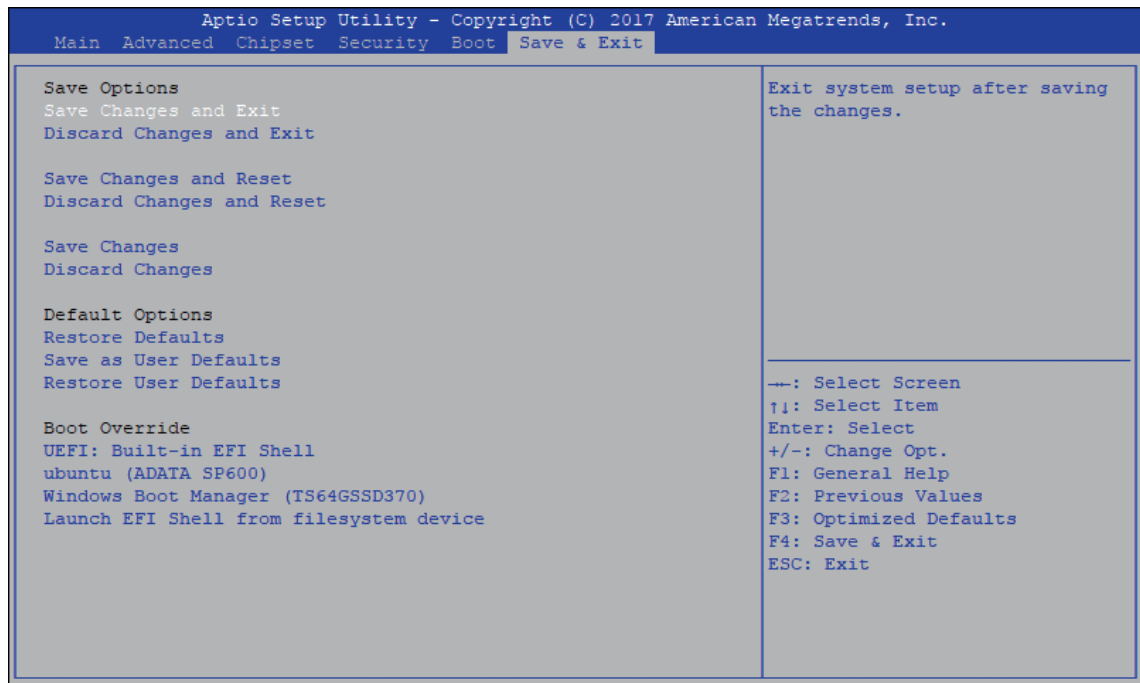

Figure 4-7 : Bios Save and Exit Menu

### Save Changes and Exit

Exit system setup after saving the changes.

### Discard Changes and Exit

Exit system setup without saving any changes.

### Save Changes and Reset

Reset the system after saving the changes.

### Discard Changes and Reset

Reset system setup without saving any changes.

### Save Changes

Save Changes done so far to any of the setup options.

### Discard Changes

Discard Changes done so far to any of the setup options.

Default Options

### Restore Defaults

Restore/Load Default values for all the setup options.

### Save as User Defaults

Save the changes done so far as User Defaults.

### Restore User Defaults

Restore the User Defaults to all the setup options

# A

## APPENDIX A : Isolated DIO Guide

### A.1 Function Description

The EVS-2000 offers two 16-bit Isolated DIO 20-pin terminal block connector and a watchdog timer.

Isolated DIO pins are fix by Hardware design that cannot change in/out direction in runtime process.

DIO definition is shown below :

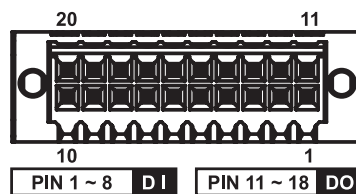

Pin No.	Isolated DIO Definition	Non-Isolated DIO Definition	Pin No.	Isolated DIO Definition	Non-Isolated DIO Definition
1	DI 0	DIO 0	11	DO 0	DIO 8
2	DI 1	DIO 1	12	DO 1	DIO 9
3	DI 2	DIO 2	13	DO 2	DIO 10
4	DI 3	DIO 3	14	DO 3	DIO 11
5	DI 4	DIO 4	15	DO 4	DIO 12
6	DI 5	DIO 5	16	DO 5	DIO 13
7	DI 6	DIO 6	17	DO 6	DIO 14
8	DI 7	DIO 7	18	DO 7	DIO 15
9	DI COM	NC	19	DIO_GND	DIO_GND
10	DIO_GND	DIO_GND	20	External VDC	NC

POE definition is shown below :

Port No.	Definition	Port No.	Definition
1	POE 0	3	POE 2
2	POE 1	4	POE 3

Do NOT use these functions in right :

1. PE-2000 : DIO1 (ID = 0), POE
2. PE-3000 : POE (ID = 0)
3. UE-1000 : USB (ID = 0)

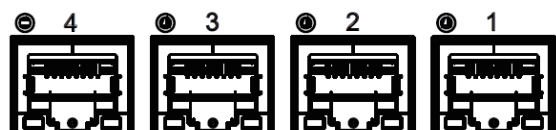

## A.2 Isolated DIO Signal Circuit

### DI Reference Circuit :

Sink Mode (NPN)

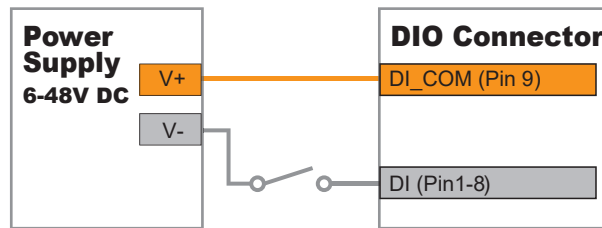

Source Mode (PNP)

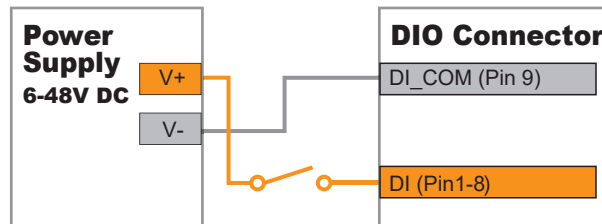

### DO Reference Circuit :

Sink Mode  
(NPN, Default)

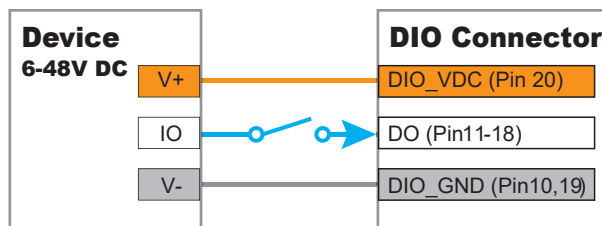

Source Mode  
(PNP)

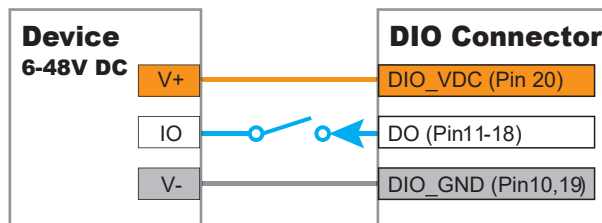

## A.3 Isolated DIO Signal Circuit

Distribution folders include x32 and x64 versions, use the batch file for driver installation.

There are included as followed :

Win10\_32.bat, and Win10\_64.bat :

Installation for driver, and

Uninstall\_32.bat, and Uninstall\_64.bat :

Uninstallation for driver

Run batch file as Administrator.









Make sure Windows version before installation.

Header folders include head file for software developer or System Integration.

Manual folders include API description.

Sample folders include sample program, driver library, and API library for Windows/Linux

Source folders include sample program source code that compile on Visual Studio 2008/ubuntu16.04.

-  Distribution
-  Header
-  Manual
-  Sample
-  Source
-  Uninstall\_32.bat
-  Uninstall\_64.bat
-  Win10\_32.bat
-  Win10\_64.bat

## A.4 Sample

Execute demo tool.

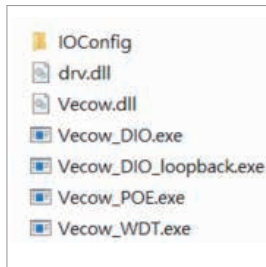

Windows

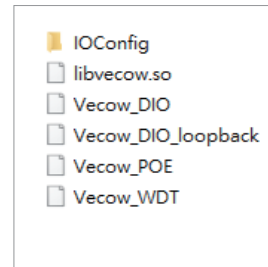

Linux

Sample, as shown below :

```
DIO sample version : v1.0.0609.0608
Load Vecow.dll at least v1.8.1409.0608
Vecow.dll Version : v1.8.1409.0608
Config : IO port I - Isolated DIO
         IO port II - Non-Isolated DIO(GPIO)

Choose IO : (1/2)
```

Vecow\_DIO

```
DIO loopback sample version : v1.0.1509.0608
Load Vecow.dll at least v1.8.1409.0608
Vecow.dll Version : v1.8.1409.0608
Config : IO port I - Isolated DIO
         IO port II - Non-Isolated DIO(GPIO)

How many IO temp_port : (1/2)
```

Vecow\_DIO\_loopback

```
POE sample version : v1.0.1609.0608
Load Vecow.dll at least v1.8.1409.0608
Vecow.dll Version : v1.8.1409.0608

Initial POE success!
Usable slave address ID : 0
Select slave address ID :
```

Vecow\_POE

```
WDT sample version : v1.0.0509.0608
Load Vecow.dll at least v1.8.1409.0608
Vecow.dll Version : v1.8.1409.0608
Config : IO port I - Isolated DIO
         IO port II - Non-Isolated DIO(GPIO)

Set WDT timer seconds (1~3932100) :
```

Vecow\_WDT

# B

## APPENDIX B : Software Functions

### B.1 Driver API Guide

In Header folder, Vecow.h and VecowLinux.h contain usable API for Windows/Linux.

#### **BOOL initial\_SIO(BYTE Isolate\_Type, BYTE DIO\_NPN)**

Initial machine for IO and watch dogtimer.

Isolate\_Type : DIO type.

1 : Isolated DIO;

0 : Non-Isolated DIO(GPIO).

DIO\_NPN : DI/DO type.

1 : PNP (Source) mode for European rule;

0 : NPN (Sink) mode for Japanese rule.

Return :

TRUE (1) : Success.

FALSE (0) : Fail (Driver not exists, or version is too old, or machine not match).

#### **BOOL get\_IO1\_configuration(BYTE \*Iso, BYTE \*DI\_mode, BYTE \*DO\_mode, WORD \*Mask)**

#### **BOOL get\_IO2\_configuration(BYTE \*Iso, BYTE \*DI\_mode, BYTE \*DO\_mode, WORD \*Mask)**

Get DIO configuration (by variable)

Isolate\_Type : DIO type.

1 : Isolated DIO;

0 : Non-Isolated DIO (GPIO).

DI\_mode ([7:0]) : DI type, pin setting by hexadecimal bitmask only for Isolated DIO.

0xFF : PNP (Source) mode for European rule;

0 : NPN (Sink) mode for Japanese rule.

DO\_mode : DO type only for Isolated DIO.

1 : PNP (Source) mode for European rule;

0 : NPN (Sink) mode for Japanese rule.

Mask ([15:0]) : In/Out, pin setting by hexadecimal bitmask only for Non-Isolated DIO(GPIO).

1 : Output;

0 : Input

Return :

TRUE (1) : Success.

FALSE (0) : Fail (Initial error, or call by pointer error, or hardware problem).

**BOOL set\_IO1\_configuration(BYTE Iso, BYTE DI\_mode, BYTE DO\_mode, WORD Mask)**

**BOOL set\_IO2\_configuration(BYTE Iso, BYTE DI\_mode, BYTE DO\_mode, WORD Mask)**

Set DIO configuration.

Isolate\_Type : DIO type.

1 : Isolated DIO;

0 : Non-Isolated DIO(GPIO).

DI\_mode ([7:0]) : DI type, pin setting by hexadecimal bitmask only for Isolated DIO.

0xFF : PNP (Source) mode for European rule;

0 : NPN (Sink) mode for Japanese rule.

DO\_mode : DO type only for Isolated DIO.

1 : PNP (Source) mode for European rule;

0 : NPN (Sink) mode for Japanese rule.

Mask ([15:0]) : In/Out, pin setting by hexadecimal bitmask only for Non-Isolated DIO(GPIO).

1 : Output;

0 : Input

Return :

TRUE (1) : Success.

FALSE (0) : Fail (Initial error or hardware problem).

**BOOL get\_DIO1(BYTE \*DO\_data, BYTE \*DI\_data)**

**BOOL get\_DIO2(BYTE \*DO\_data, BYTE \*DI\_data)**

Get isolated DIO output(DO) and input (DI).

DI ([7:0]) : Input state, pin setting by hexadecimal bitmask.

1 : High;

0 : Low.

DO ([7:0]) : Output state, pin setting by hexadecimal bitmask.

1 : High;

0 : Low.

Return :

TRUE (1) : Success.

FALSE (0) : Fail (Initial error or hardware problem).

FALSE (0) : Fail (Initial error or hardware problem).

**BOOL set\_DIO1(BYTE DO\_data)**

**BOOL set\_DIO2(BYTE DO\_data)**

Set isolated DIO output(DO).

DO ([7:0]) : Output state, pin setting by hexadecimal bitmask.

1 : High;

0 : Low.

Return :

TRUE (1) : Success.

FALSE (0) : Fail (Initial error or hardware problem).

FALSE (0) : Fail (Initial error or hardware problem).



**BOOL get\_GPIO1(WORD \*GPIO\_data)**

Get GPIO.

GPIO\_data ([15:0]) : GPIO state, pin setting by hexadecimal bitmask.

1 : High;

0 : Low.

Return :

TRUE (1) : Success.

FALSE (0) : Fail (Initial error or hardware problem).

**BOOL set\_GPIO1(WORD GPIO\_data)**

Set GPIO.

GPIO\_data ([15:0]) : GPIO state, pin setting by hexadecimal bitmask.

1 : High;

0 : Low.

Return :

TRUE (1) : Success.

FALSE (0) : Fail (Initial error or hardware problem).

**BOOL get\_WDT(DWORD \*WDT)**

Get watchdog timer setup.

WDT : watchdog timer setup.

Unit : second (Range : 0 ~ 65535 sec, 1093 ~ 65535 min (=65580 ~ 3932100 sec)).

Return :

TRUE (1) : Success.

FALSE (0) : Fail (Initial error, or call by pointer error, or hardware problem).

**BOOL set\_WDT(DWORD WDT)**

Set watchdog timer setup.

WDT : watchdog timer setup.

Unit : second (Range : 0 ~ 65535 sec, 1093 ~ 65535 min (=65580 ~ 3932100 sec)).

Return :

TRUE (1) : Success.

FALSE (0) : Fail (Initial error, or setup 0, or hardware problem).

**BOOL cancel\_WDT()**

Cancel watchdog timer.

Return :

TRUE (1) : Success.

FALSE (0) : Fail (Initial error or hardware problem).

### **BOOL initial\_POE(BYTE Scan, BYTE ID)**

Initial POE.

Scan : POEID scan type

2 : Auto scan;

1 : Manual setup.

ID : POE ID by manual setting.

Range : 0~15.

Return :

TRUE (1) : Success.

FALSE (0) : Fail (Driver not exists, or version is too old, or out of range error).

### **BOOL get\_POE\_configuration(BYTE ID, BYTE \*Auto, BYTE \*Mask)**

Get POE configuration (by variable).

ID : POE ID.

Range : 0~15.

Auto ([3:0]) : Auto mode, pin setting by hexadecimal bitmask.

1 : Auto;

0 : Manual.

Mask ([3:0]) : DC Enable/Disable, pin setting by hexadecimal bitmask.

1 : Enable;

0 : Disable.

Return :

TRUE (1) : Success.

FALSE (0) : Fail (Initial error, or out of range error, or call by pointer error, or hardware problem)

### **BOOL set\_POE\_configuration(BYTE ID, BYTE Auto, BYTE Mask)**

Set POE configuration (by variable).

ID : POE ID.

Range : 0~15.

Auto ([3:0]) : Auto mode, pin setting by hexadecimal bitmask.

1 : Auto;

0 : Manual.

Mask ([3:0]) : DC Enable/Disable, pin setting by hexadecimal bitmask.

1 : Enable;

0 : Disable.

Return :

TRUE (1) : Success.

FALSE (0) : Fail (Initial error, or out of range error, or hardware problem).

**BOOL get\_POE(BYTE ID, BYTE \*POE)**

Get POE state.

ID : POE ID.

Range : 0~15.

POE ([3:0]) : POE state, pin setting by hexadecimal bitmask.

1 : On;

0 : Off.

Return :

TRUE (1) : Success.

FALSE (0) : Fail (Initial error, or out of range error, or call by pointer error, or hardware problem).

**BOOL set\_POE(BYTE ID, BYTE POE)**

Set POE state.

A. ID : POE ID.

Range : 0~15.

B. POE ([3:0]) : POE state, pin setting by hexadecimal bitmask.

1 : On;

0 : Off.

Return :

TRUE (1) : Success.

FALSE (0) : Fail (Initial error, or out of range error, or hardware problem).

# C

## APPENDIX C : RAID Functions

### C.1.1 SATA Mode for RAID

Please select SATA Device to RAID mode on BIOS menu.  
Chipset → PCH-IO Configuration → SATA And RST Configuration → SATA Mode Selection → Intel RST Premium → Save Changes and Reset.

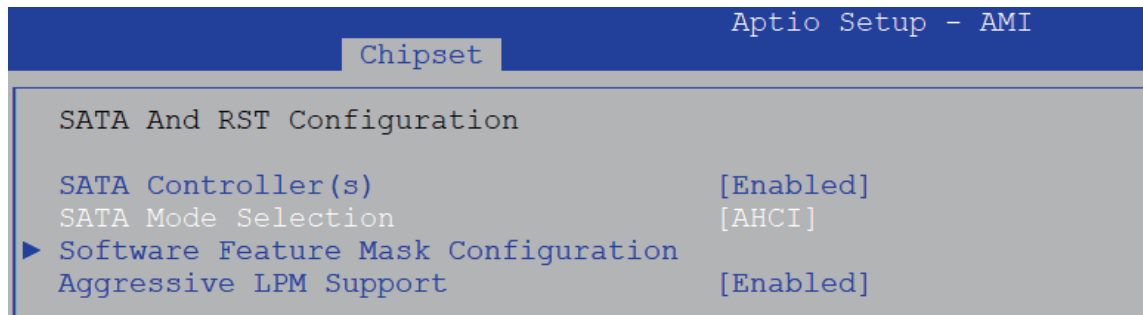

### C.1.2 UEFI Mode for RAID

1. Into BIOS menu again, select Intel(R) Rapid Storage Technology on BIOS menu.  
Advanced → Intel(R) Rapid Storage Technology

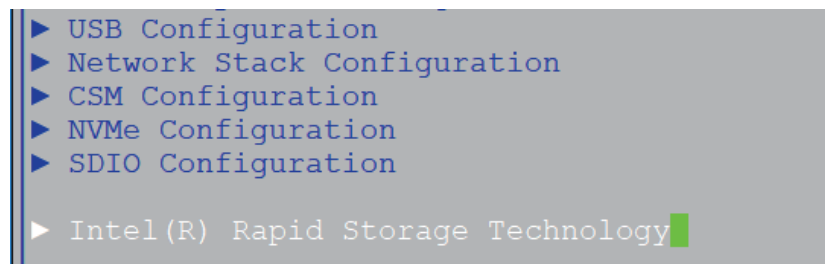

2. Select Create RAID Volume on BIOS menu.

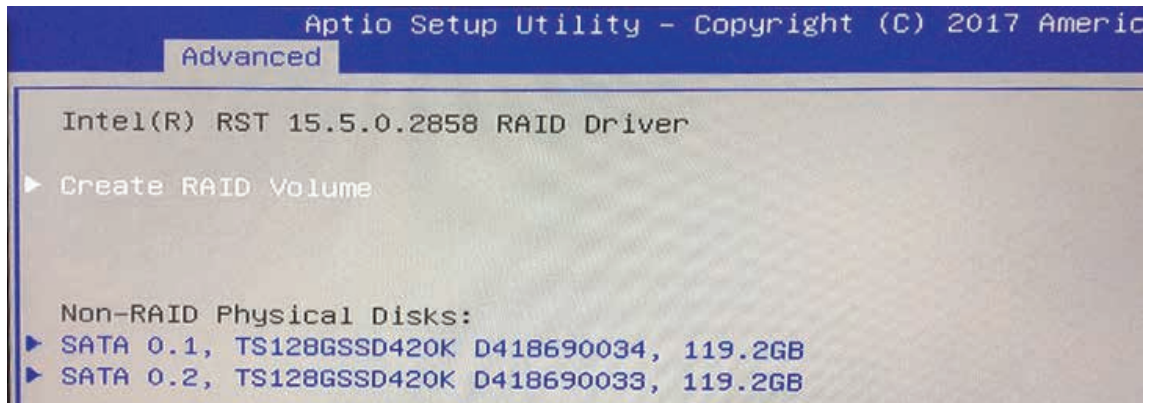

3. Select disks to create RAID Volume then Save Changes and Reset to install OS with EFI mode.

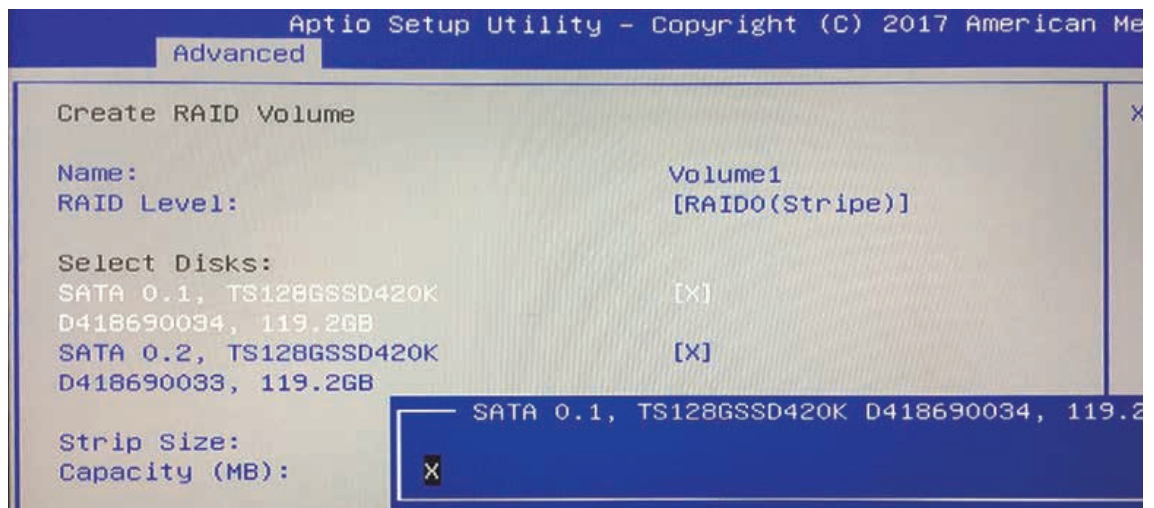

## C.2 OS Installation

The system is featured with one M.2 key B, one M.2 key M for NVME, one mSATA slot, and including two internal SATA.

We used SATA for Windows 10 OS installation as an example.

## C.3 To Install All Device Drivers of the System

The instructions are as follows :

1. Install Chipset driver
2. Install Network driver
3. Install ME driver (if available)
4. Install Audio driver
5. Install VGA driver

## C.4 To Install "Intel Rapid Storage Technology" Software

You can get the latest information and the software directly from Intel website.

[http://www.intel.com/p/en\\_US/support/highlights/chpsts/imsm](http://www.intel.com/p/en_US/support/highlights/chpsts/imsm)

The RAID environment has been done if you completed the steps above.

## C.5 To Insert SATA HDD for RAID 1

Please note, you can use two SATA ports for SATA HDD, except for mSATA slot.

## C.6 To Create RAID Volume on "Rapid Storage Technology" Software

The system is featured with two SATA HDD's for RAID volume, so there are two options to choose on this page. Let's take RAID 1 as an example, select "RAID 1".

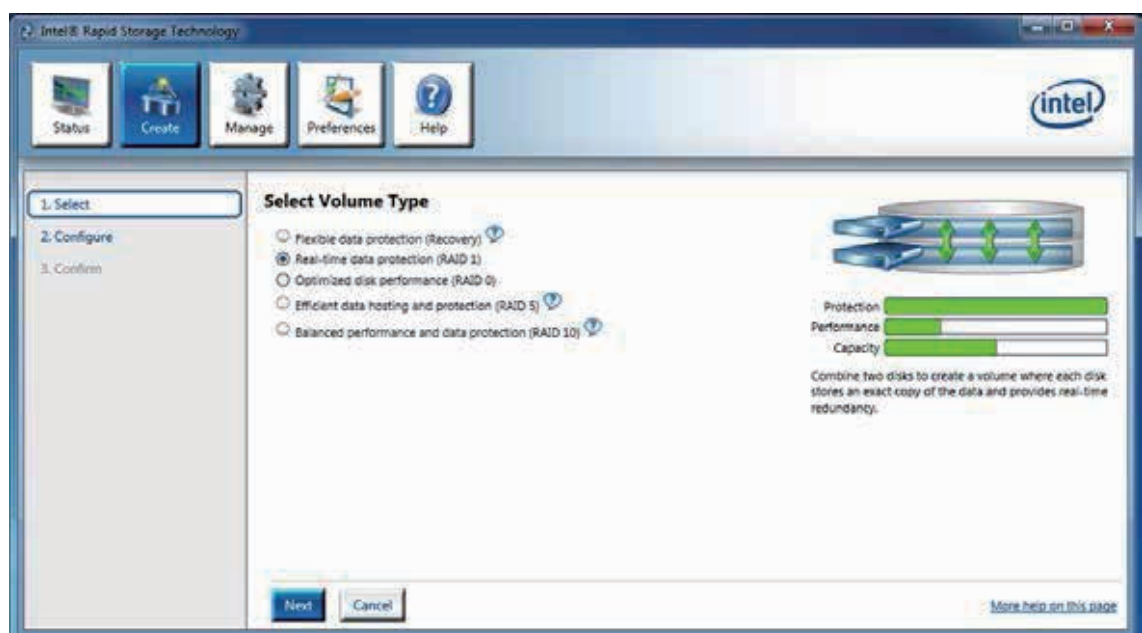

## C.7 Disk Management : Partition the Disk

After RAID 1 volume is created, you can see the figure of SATA device allocation.

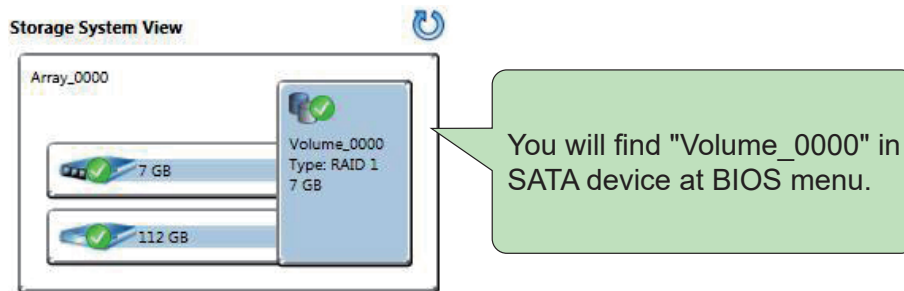

To start disk management tool, select "initialize disk".

Then add "Logical Device" for Windows access.

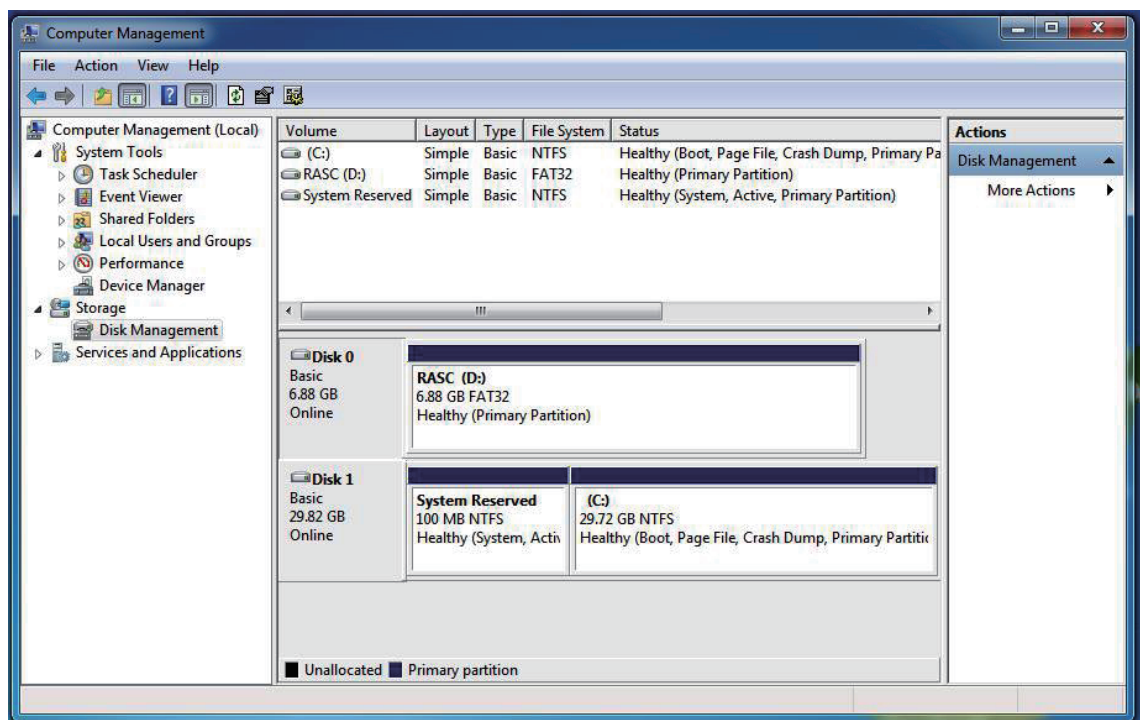

## C.8 If One SATA HDD on RAID Volume is Out-of-use

After RAID 1 volume is created, you can see the figure of SATA device allocation.

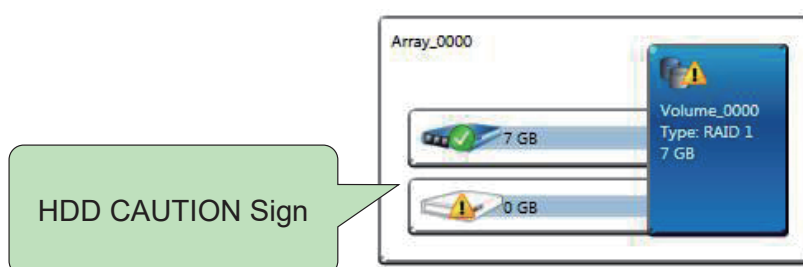

## C.9 Recovery and Auto Re-build When Using the SAME RAID HDD

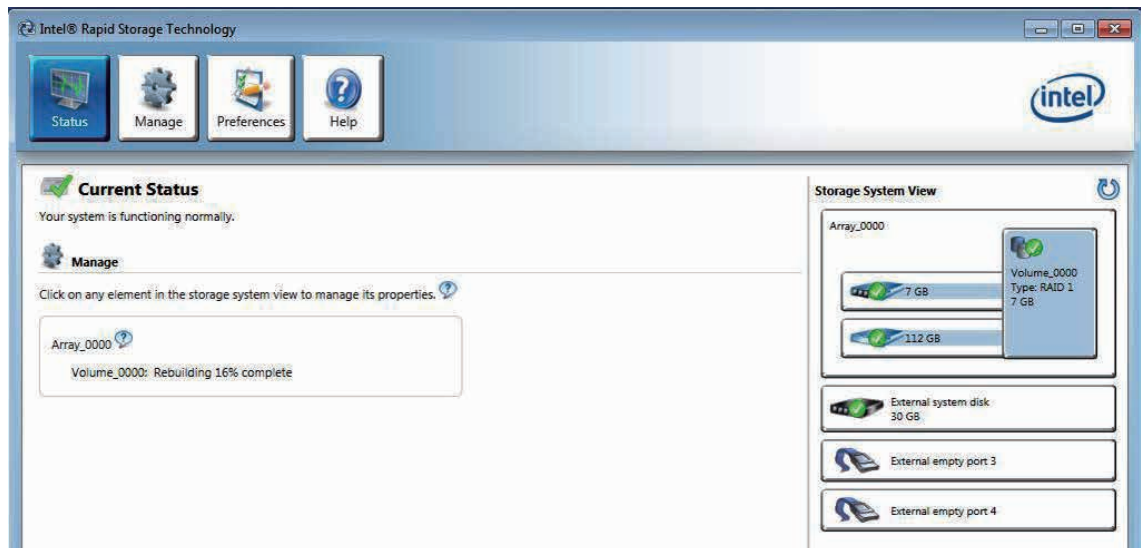

## C.10 Recovery and Auto Re-build When Using DIFFERENT RAID HDD

A warning will pop-up to ask you if the disk is not a member of the original RAID volume.

If you press "Rebuild", it will replace the broken SATA HDD to the last SATA HDD of RAID volume.

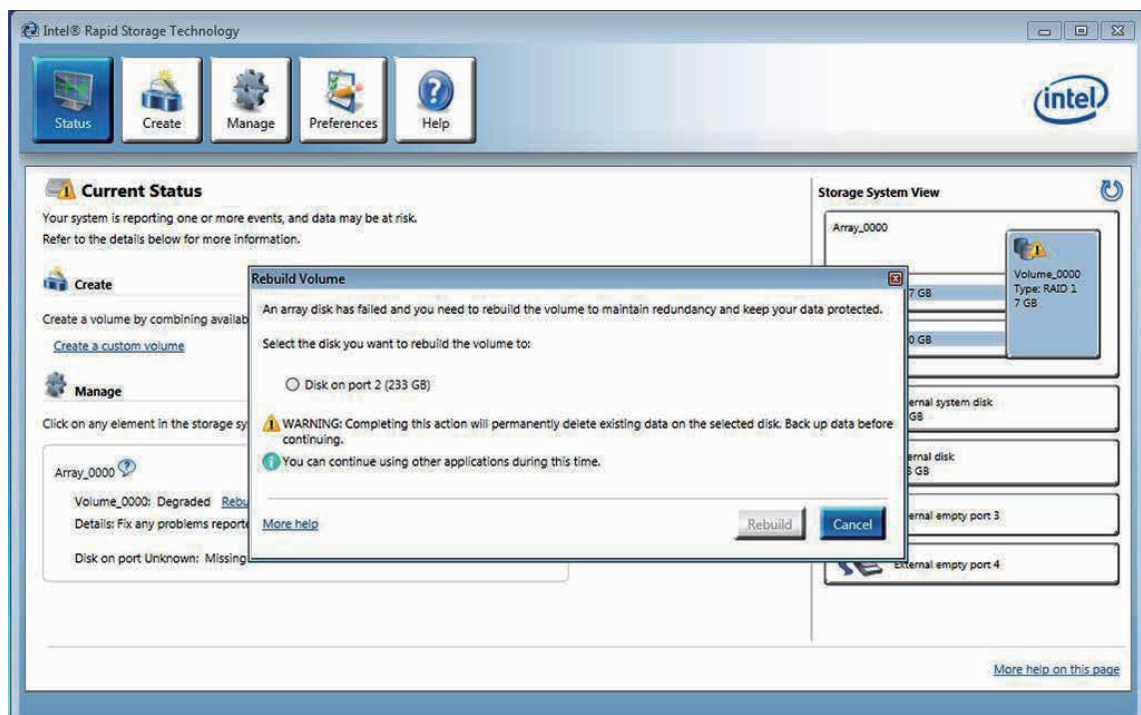



# D

## APPENDIX D : Power Consumption

Testing Board	EVS-2000
RAM	16GB * 2
USB-1	USB Keyboard Microsoft 600
USB-2	USB Mouse Logitech M105
USB-3	USB Flash Transecnd 3.0 8GB
USB-4	USB Flash Transecnd 3.0 8GB
USB-5	USB Flash Kingston 2.0 16GB
USB-6	USB Flash Kingston 2.0 16GB
M.2 M Key	FORESEE FSGPMMC-256G 256GB
SATA 0	HGST Z5K500-500 500GB
LAN 1 (i219)	1.0 Gbps
LAN 2 (i210)	1.0 Gbps
Graphics output	DVI
Power plan	Balance (Windows10 Power plan)
Power Source	Chroma 62006P-100-25
Test Program-1	BurnInTest 8.1
Test Program-2	FurMark 1.21.2.0 (1920 x 1080, 8X MSAА)

## D.1 Intel® Core™ i5-10500E (12M Cache, 3.10GHz)

Power on and boot to Win 10 (64-bit)

CPU	Power Input	Standby Mode		Power on and boot to Win 10 (64-bit)			
				Sleep Mode		Idle status CPU usage less 3%	
		Max Current	Max Consumption	Max Current	Max Consumption	Max Current	Max Consumption
Core™ i5-10500E	09V	0.426A	03.83W	0.495A	04.46W	1.667A	15.00W
Core™ i5-10500E	12V	0.302A	03.62W	0.379A	04.54W	1.551A	18.61W
Core™ i5-10500E	24V	0.197A	04.73W	0.253A	06.06W	0.921A	22.10W
Core™ i5-10500E	36V	0.166A	05.98W	0.211A	07.59W	0.661A	23.78W
Core™ i5-10500E	48V	0.147A	07.06W	0.188A	09.01W	0.543A	26.06W
Core™ i5-10500E	50V	0.144A	07.22W	0.184A	09.18W	0.534A	26.70W

CPU	Power Input	Power on and boot to Win 10 (64-bit)			
		Run 100% CPU usage without 3D		Run 100% CPU usage with 3D	
		Max Current	Max Consumption	Max Current	Max Consumption
Core™ i5-10500E	09V	5.745A	51.70W	7.829A	70.46W
Core™ i5-10500E	12V	4.316A	51.80W	5.882A	70.58W
Core™ i5-10500E	24V	2.254A	54.09W	3.042A	73.00W
Core™ i5-10500E	36V	1.617A	58.21W	1.984A	71.43W
Core™ i5-10500E	48V	1.243A	59.65W	1.638A	78.63W
Core™ i5-10500E	50V	1.203A	60.17W	1.589A	79.45W

## D.2 Intel® Core™ i9-10900TE (20M Cache, 1.80GHz)

Power on and boot to Win 10 (64-bit)

CPU	Power Input	Standby Mode		Power on and boot to Win 10 (64-bit)			
				Sleep Mode		Idle status CPU usage less 3%	
		Max Current	Max Consumption	Max Current	Max Consumption	Max Current	Max Consumption
Core™ i9-10900TE	09V	0.412A	03.71W	0.508A	04.58W	2.016A	18.14W
Core™ i9-10900TE	12V	0.310A	03.72W	0.389A	04.67W	1.517A	18.20W
Core™ i9-10900TE	24V	0.199A	04.77W	0.252A	06.04W	0.835A	20.04W
Core™ i9-10900TE	36V	0.169A	06.07W	0.213A	07.68W	0.673A	24.21W
Core™ i9-10900TE	48V	0.149A	07.16W	0.189A	09.06W	0.541A	25.94W
Core™ i9-10900TE	50V	0.146A	07.32W	0.186A	09.29W	0.524A	26.18W

CPU	Power Input	Power on and boot to Win 10 (64-bit)			
		Run 100% CPU usage without 3D		Run 100% CPU usage with 3D	
		Max Current	Max Consumption	Max Current	Max Consumption
Core™ i5-10500E	09V	4.423A	39.81W	7.013A	63.12W
Core™ i5-10500E	12V	3.288A	39.45W	5.283A	63.40W
Core™ i5-10500E	24V	1.770A	42.48W	2.679A	64.29W
Core™ i5-10500E	36V	1.247A	44.87W	1.867A	67.22W
Core™ i5-10500E	48V	0.987A	47.40W	1.459A	70.01W
Core™ i5-10500E	50V	0.959A	47.93W	1.409A	70.44W

## D.3 Intel® Core™ i5-10500E (12M Cache, 3.10GHz) with MX RTX 2070

Power on and boot to Win 10 (64-bit)

CPU	Power Input	Standby Mode		Power on and boot to Win 10 (64-bit)			
				Sleep Mode		Idle status CPU usage less 3%	
		Max Current	Max Consumption	Max Current	Max Consumption	Max Current	Max Consumption
Core™ i5-10500E	12V	0.298A	03.58W	0.387A	04.64W	2.322A	27.86W
Core™ i5-10500E	24V	0.197A	04.72W	0.257A	06.16W	1.357A	32.56W
Core™ i5-10500E	36V	0.167A	06.00W	0.216A	07.77W	1.022A	36.80W
Core™ i5-10500E	48V	0.147A	07.04W	0.189A	09.09W	0.810A	38.88W
Core™ i5-10500E	50V	0.144A	07.20W	0.187A	09.35W	0.728A	36.40W

CPU	Power Input	Power on and boot to Win 10 (64-bit)			
		Run 100% CPU usage without 3D		Run 100% CPU usage with Furmark	
		Max Current	Max Consumption	Max Current	Max Consumption
Core™ i5-10500E	12V	5.474A	65.69W	15.092A	181.10W
Core™ i5-10500E	24V	2.778A	66.67W	7.686A	184.47W
Core™ i5-10500E	36V	1.911A	68.79W	5.258A	189.27W
Core™ i5-10500E	48V	1.481A	71.11W	4.031A	193.50W
Core™ i5-10500E	50V	1.428A	71.40W	3.949A	197.45W

## D.4 Intel® Core™ i5-10500E (12M Cache, 3.10GHz) with MXM T1000

Power on and boot to Win 10 (64-bit)

CPU	Power Input	Standby Mode		Power on and boot to Win 10 (64-bit)			
				Sleep Mode		Idle status CPU usage less 3%	
		Max Current	Max Consumption	Max Current	Max Consumption	Max Current	Max Consumption
Core™ i5-10500E	12V	0.296A	03.55W	0.383A	04.60W	2.447A	29.36W
Core™ i5-10500E	24V	0.194A	04.66W	0.253A	06.07W	1.313A	31.51W
Core™ i5-10500E	36V	0.166A	05.98W	0.218A	07.85W	0.941A	33.88W
Core™ i5-10500E	48V	0.147A	07.06W	0.190A	09.12W	0.775A	37.20W
Core™ i5-10500E	50V	0.144A	07.20W	0.187A	09.35W	0.744A	37.20W

CPU	Power Input	Power on and boot to Win 10 (64-bit)			
		Run 100% CPU usage without 3D		Run 100% CPU usage with Furmark	
		Max Current	Max Consumption	Max Current	Max Consumption
Core™ i5-10500E	12V	5.224A	62.69W	8.723A	104.68W
Core™ i5-10500E	24V	2.706A	64.94W	4.502A	108.05W
Core™ i5-10500E	36V	1.892A	68.11W	3.113A	112.07W
Core™ i5-10500E	48V	1.495A	71.76W	2.427A	116.50W
Core™ i5-10500E	50V	1.439A	71.95W	2.319A	115.95W

## D.5 Intel® Core™ i5-10500E (12M Cache, 3.10GHz) with MXM P2000

Power on and boot to Win 10 (64-bit)

CPU	Power Input	Standby Mode		Power on and boot to Win 10 (64-bit)			
				Sleep Mode		Idle status CPU usage less 3%	
		Max Current	Max Consumption	Max Current	Max Consumption	Max Current	Max Consumption
Core™ i5-10500E	12V	0.298A	03.58W	0.386A	04.63W	2.109A	25.31W
Core™ i5-10500E	24V	0.195A	04.68W	0.260A	06.24W	1.172A	28.14W
Core™ i5-10500E	36V	0.166A	05.98W	0.215A	07.74W	0.865A	31.14W
Core™ i5-10500E	48V	0.147A	07.06W	0.189A	09.07W	0.668A	32.06W
Core™ i5-10500E	50V	0.144A	07.20W	0.187A	09.35W	0.663A	33.15W

CPU	Power Input	Power on and boot to Win 10 (64-bit)			
		Run 100% CPU usage without 3D		Run 100% CPU usage with Furmark	
		Max Current	Max Consumption	Max Current	Max Consumption
Core™ i5-10500E	12V	5.000A	60.00W	8.451A	101.41W
Core™ i5-10500E	24V	2.600A	62.40W	4.301A	103.22W
Core™ i5-10500E	36V	1.847A	66.49W	2.942A	105.91W
Core™ i5-10500E	48V	1.416A	67.97W	2.283A	109.58W
Core™ i5-10500E	50V	1.370A	68.50W	2.186A	109.30W

## D.6 Intel® Core™ i5-10500E (12M Cache, 3.10GHz) with MXM GTX 1650

Power on and boot to Win 10 (64-bit)

CPU	Power Input	Standby Mode		Power on and boot to Win 10 (64-bit)			
				Sleep Mode		Idle status CPU usage less 3%	
		Max Current	Max Consumption	Max Current	Max Consumption	Max Current	Max Consumption
Core™ i5-10500E	12V	0.302A	03.62W	0.382A	04.59W	2.545A	30.54W
Core™ i5-10500E	24V	0.198A	04.74W	0.249A	05.98W	1.329A	31.90W
Core™ i5-10500E	36V	0.168A	06.03W	0.212A	07.61W	0.969A	34.90W
Core™ i5-10500E	48V	0.148A	07.11W	0.188A	09.03W	0.764A	36.68W
Core™ i5-10500E	50V	0.144A	07.20W	0.186A	09.32W	0.697A	34.85W

CPU	Power Input	Power on and boot to Win 10 (64-bit)			
		Run 100% CPU usage without 3D		Run 100% CPU usage with Furmark	
		Max Current	Max Consumption	Max Current	Max Consumption
Core™ i5-10500E	12V	5.155A	61.86W	10.170A	122.04W
Core™ i5-10500E	24V	2.651A	63.62W	5.186A	124.46W
Core™ i5-10500E	36V	1.877A	67.58W	3.537A	127.34W
Core™ i5-10500E	48V	1.447A	69.45W	2.734A	131.24W
Core™ i5-10500E	50V	1.393A	69.65W	2.617A	130.85W

## D.7 Intel® Core™ i5-10500E (12M Cache, 3.10GHz) with MXM GTX 1050

Power on and boot to Win 10 (64-bit)

CPU	Power Input	Standby Mode		Power on and boot to Win 10 (64-bit)			
				Sleep Mode		Idle status CPU usage less 3%	
		Max Current	Max Consumption	Max Current	Max Consumption	Max Current	Max Consumption
Core™ i5-10500E	12V	0.297A	03.56W	0.384A	04.61W	2.068A	24.82W
Core™ i5-10500E	24V	0.195A	04.68W	0.253A	06.07W	1.297A	31.13W
Core™ i5-10500E	36V	0.166A	05.98W	0.216A	07.78W	0.914A	32.90W
Core™ i5-10500E	48V	0.144A	06.91W	0.186A	08.93W	0.719A	34.51W
Core™ i5-10500E	50V	0.143A	07.15W	0.184A	09.20W	0.682A	34.10W

CPU	Power Input	Power on and boot to Win 10 (64-bit)			
		Run 100% CPU usage without 3D		Run 100% CPU usage with Furmark	
		Max Current	Max Consumption	Max Current	Max Consumption
Core™ i5-10500E	12V	4.941A	59.29W	7.596A	91.15W
Core™ i5-10500E	24V	2.555A	61.32W	3.882A	93.17W
Core™ i5-10500E	36V	1.801A	64.85W	2.696A	97.06W
Core™ i5-10500E	48V	1.434A	68.83W	2.095A	100.56W
Core™ i5-10500E	50V	1.373A	68.65W	2.014A	100.70W



# E

## APPENDIX E : Supported Memory & Storage List

### E.1 Supported Memory List

Testing Board	EVS-2000
CPU	version : 5.1
Memory Test	V5.01
BurnInTest	V8.1

### E.2 Test Item

Channel	Memory Test	Burn In	Flash BIOS	Remove Battery
*2	PASS	PASS	PASS	PASS
*1 (Socket 1)	PASS	PASS	N/A	PASS
*1 (Socket 2)	PASS	PASS	N/A	PASS

## E.3 NON-ECC

Brand	Info	Test Temp. (Celsius)
SLINK DDR4 32GB 3200 SODIMM	J4BGSH2G8TMFC	25°C
		25°C
SLINK DDR4 16GB 3200 SODIMM	J4AGSH1G8TMFC	25°C
		25°C
SLINK DDR4 8GB 3200 SODIMM	J48GSH1G8TMEC	25°C
		25°C
Innodisk 16GB DDR4 2933 W/T SODIMM	M4S0-AGS1O5UN-H03	25°C
		25°C
Innodisk 16GB DDR4 3200 W/T SODIMM	M4S0-AGS1O5EM-H03	25°C
		25°C
Innodisk 16GB DDR4 2933 SODIMM	M4S0-AGS1OCUN-H03	25°C
		25°C

## E.4 Supported Storage Device List

Type	Brand	Model	Capacity
mSATA	Toshiba	THNSNS128GMCP	120GB
SATA SSD	SAMSUNG	860 EVO	250GB
	FORESEE	F5CKMMC-128G	128GB
	Kingston	SUV500/120G	120GB
M.2 M Key NVMe	FORESEE	F5GPMMC-256G	256GB
	INTEL	SSD 760p	128GB
	SAMSUNG	970 EVO Plus	250GB
M.2 B Key NVMe	Kingston	SA1000MB/240G	240GB

\*\* If more help is needed, please contact Vecow Technical Support.\*\*

# F

## APPENDIX F : Install Win11 (BIOS TPM Setting)

**Step 1** Click on “Advanced”, then click on “PCH-FW Configuration”

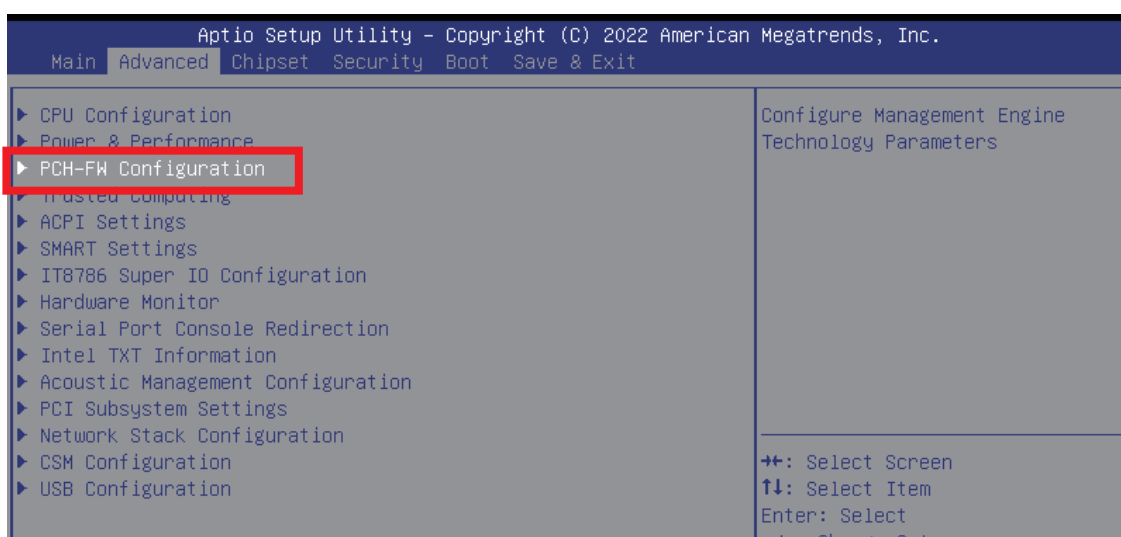

**Step 2** Click on “PTT Configuration”

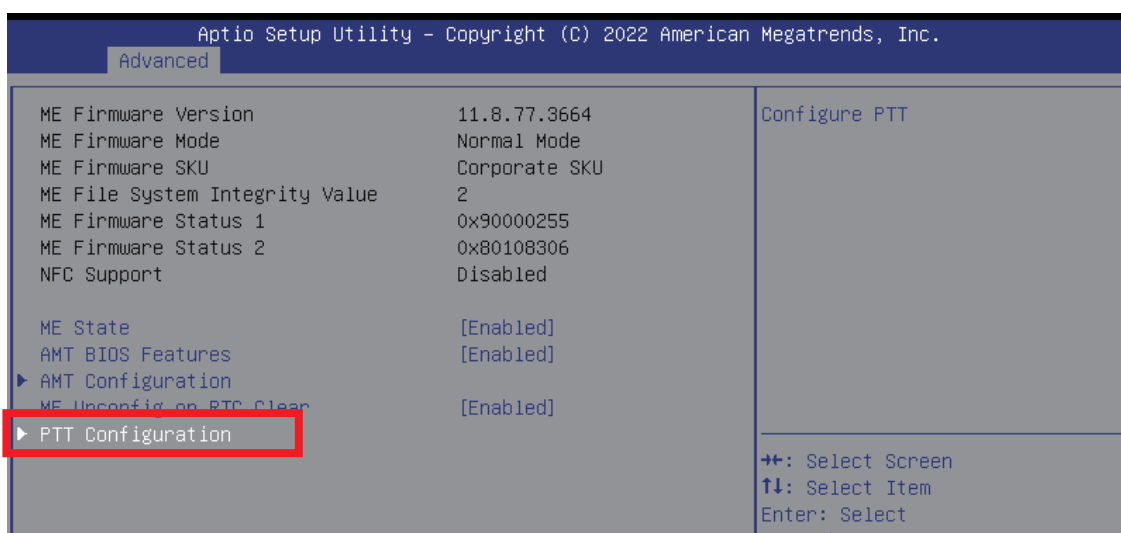

### Step 3 Click on “dTPM” (TPM Device Selection)

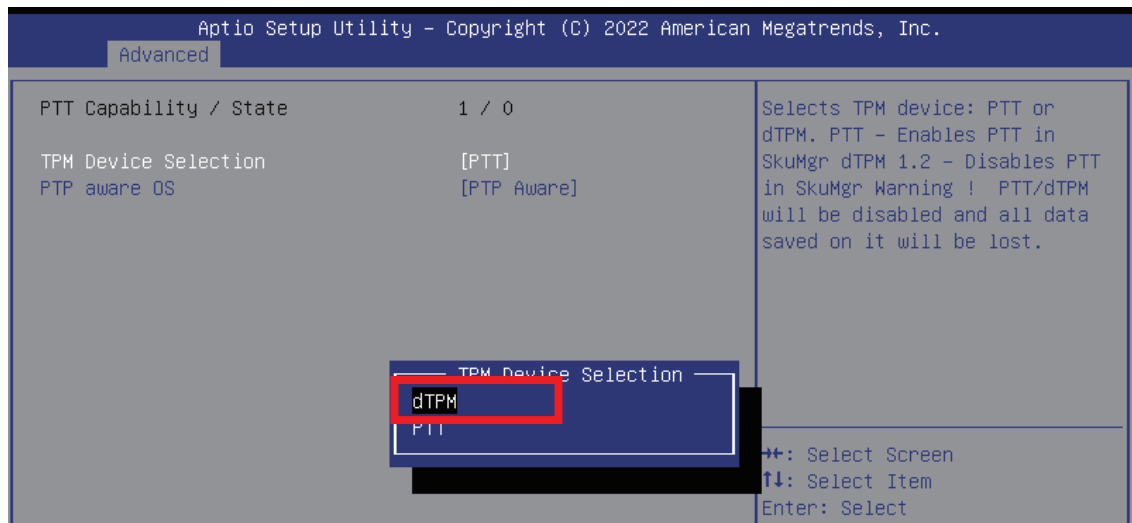

### Step 4 Please save the BIOS settings by pressing F4. Please press Enter when the pop-up window which asks “Save configuration and exit?” appears. The computer will then restart.

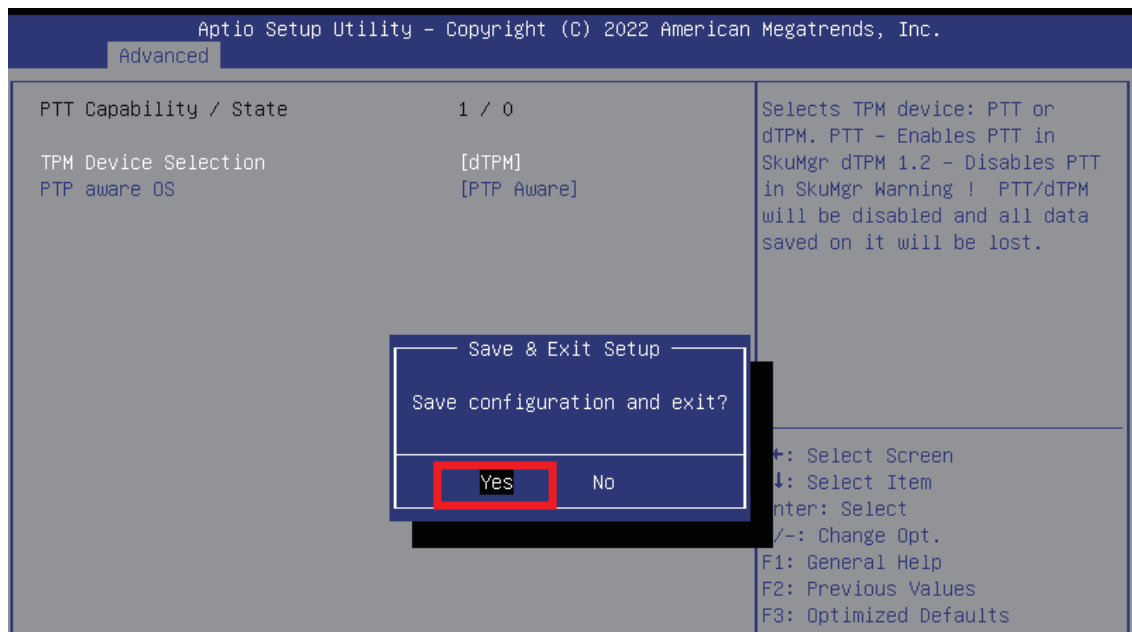

### Step 5 Click on “Trusted Computing”

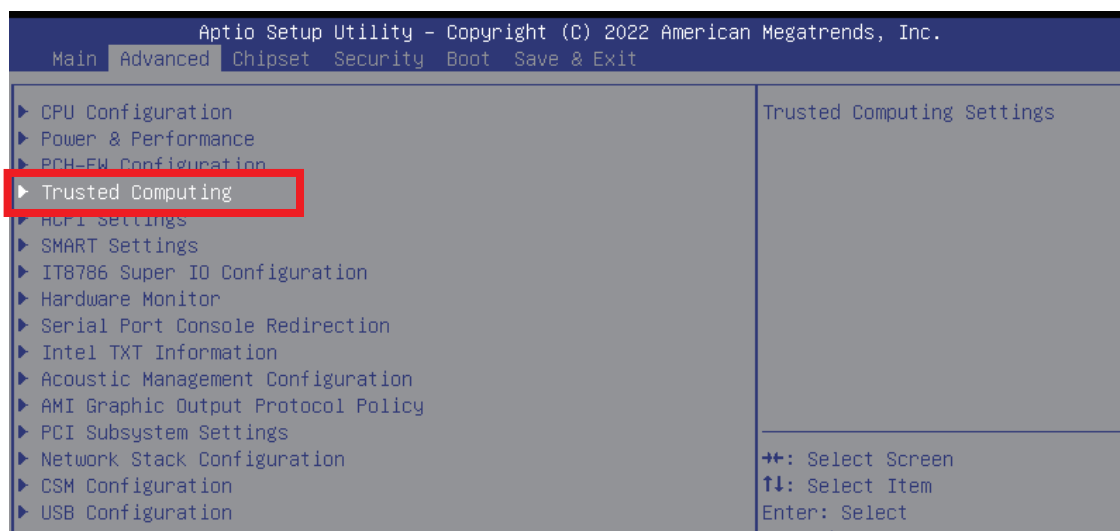

### Step 6 If the window shows “TPM2.0 Device Found Firmware Version:5.62”, then the setting is completed.

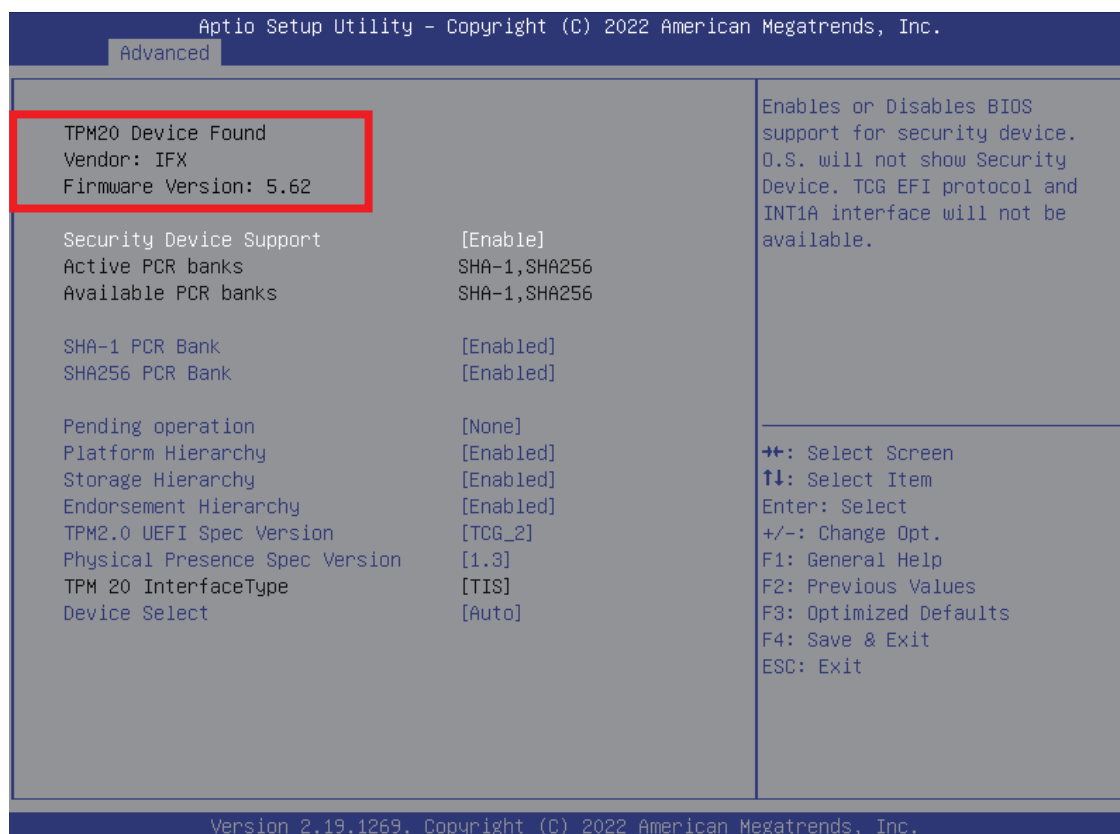

\*\* If more help is needed, please contact Vecow technical support \*\*



For further support information, please visit [www.vecow.com](http://www.vecow.com)

This document is released for reference purpose only.

All product offerings and specifications are subject to change without prior notice.

No part of this publication may be reproduced in any form or by any means, electric, photocopying, or recording, without prior authorization from the publisher.

The rights of all the brand names, product names, and trademarks belong to their respective owners.

© Vecow Co., Ltd. 2023. All rights reserved.